

PRODUCT CATALOG

Quality Products To Protect People™



INTRODUCTION

PAULSON International is very excited to release its brand new Product Catalog. Our latest Product Catalog is your comprehensive guide to product selection for the Personal Protection Equipment (PPE) manufactured by PAULSON Manufacturing.

All products of our new Product Catalog were designed to meet the many different safety needs and standards of industry worldwide.

We always think globally, act dynamically and remain true to the values that made PAULSON a global market leader in the international PPE world: openness for innovation and customized product solutions, plus striving towards excellence and trusting partnerships with our customers. For us, customer satisfaction always has the highest priority.

For more detailed product information, including photos, specifications and features, please visit our website:

www.paulson-international.com

Please feel free to also call us for additional information and price offers:
+49 (0) 69 90 50 585-0

To download an electronic copy of our new Product Catalog, please go to our website:

www.paulson-international.com/media/product-catalogs

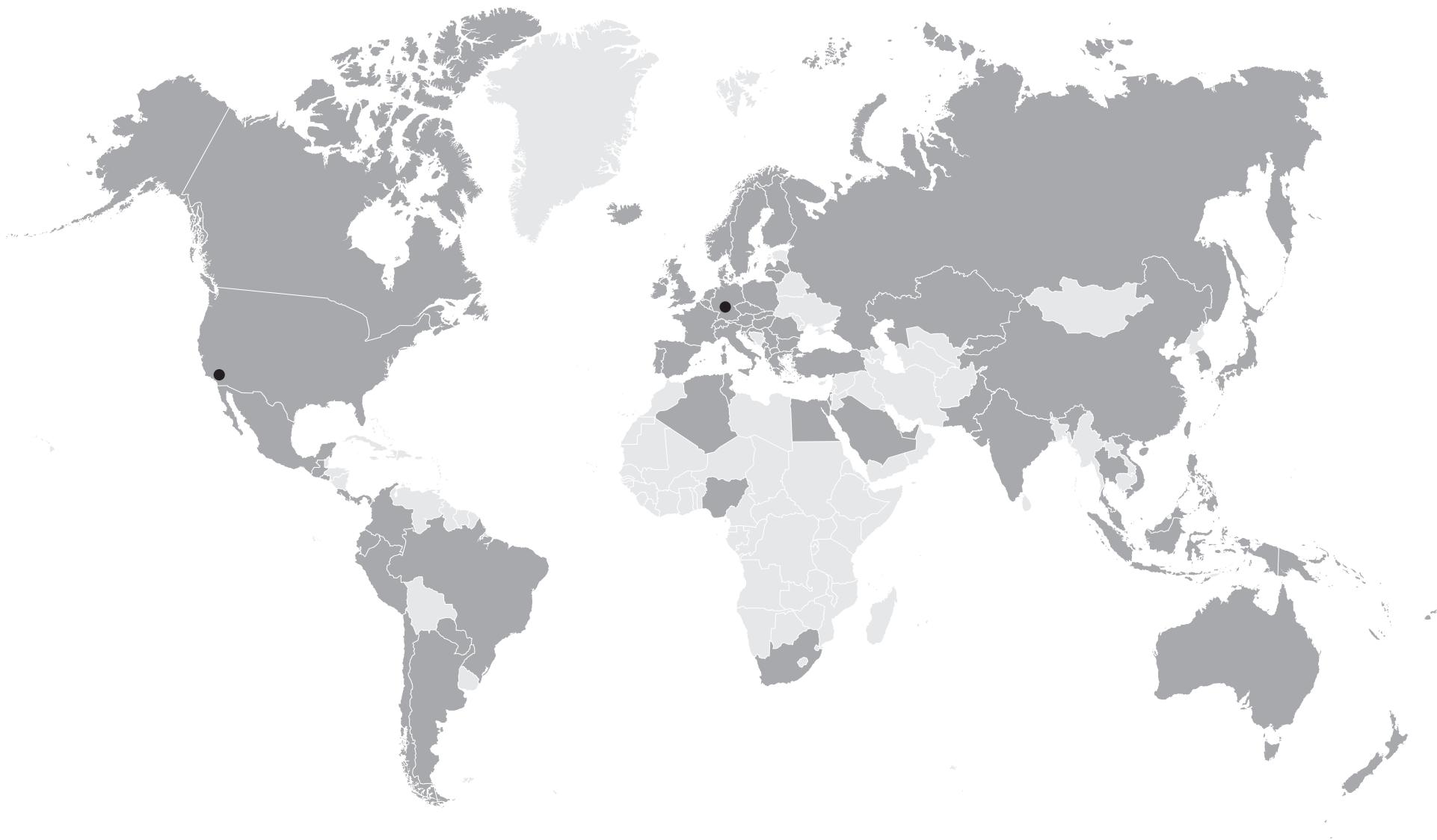

ABOUT

PAULSON INTERNATIONAL – Quality Products To Protect People™

Since 1947 PAULSON Manufacturing, located in Temecula, USA, develops, manufactures and distributes eye and face protection to industry worldwide. PAULSON Manufacturing specializes in high quality Arc Flash, Industrial, Tactical, Fire and Medical PPE, to provide maximum protection from a variety of hazards including arc flash, extreme heat, high impact, molten metal, plasma, energy discharge and chemical splash.

As PAULSON Manufacturing is vertically integrated, everything is done in-house. All phases of production, from designing the products to making the tooling, injection molding, machining, assembling, packaging and labeling, everything is done at the factory in the USA. This allows PAULSON Manufacturing to maintain a rigorous quality control program in accordance with ISO 9001:2015, to have great flexibility in offering innovative engineering solutions, and, to offer customized product solutions for specific applications and individual requirements.

PAULSON Manufacturing is committed in consulting and assisting its customers to understand the specific safety needs in order to develop product solutions, specifically tailored to protect workers from particular workplace hazards and integrate them with existing safety practices.

PAULSON Manufacturing designs and manufactures its PPE to be easy to use, comfortable, and as durable as possible to encourage workers to use it whenever and wherever necessary. A strong focus on quality is vital to saving lives.

Since 2004, PAULSON International, the international sales entity of PAULSON Manufacturing, distributes these high quality products to the entire world by a globally acting network of authorized distributors.

Meanwhile, PAULSON International is represented in 79 countries with over 270 authorized distributors.

The headquarter and warehouse of PAULSON International is located in Frankfurt/Main, Germany.

TABLE OF CONTENTS

ARC FLASH PPE

AMPSHIELD®	
3PHASE®	
ARC SHIELDS FOR HOODS	
ARC GOGGLES AND BALACLAVAS	
ECO ARC SHIELD	
EUROPEAN CLASS 1 ARC SHIELDS	

INDUSTRIAL PPE

METALIZED FACE SHIELDS	
HIGH TEMPERATURE FACE SHIELDS	
HIGH PERFORMANCE FACE SHIELDS	
SHADED FACE SHIELDS	
QUICKVIEW™	
SPECIALTY FACE SHIELDS	
SUN SHIELDS	
SPECIALTY GOGGLES	
KNEE SHIELDS	

9 TACTICAL PPE

10	BODY AND CAPTURE SHIELDS	80
20	BALLISTIC BODY SHIELD	84
26	FACE SHIELDS	86
30	LASER PROTECTION	90
34	GOGGLES	92
38	KNEE SHIELDS	94

43 FIREFIGHTER PPE

44	STRUCTURAL GOGGLES	98
50	WILDLAND GOGGLES	100

60 MEDICAL PPE

64	REUSABLE IDC FACE SHIELDS	104
68	DISPOSABLE IDC FACE SHIELDS AND GOGGLES	106

72		
74		
76		

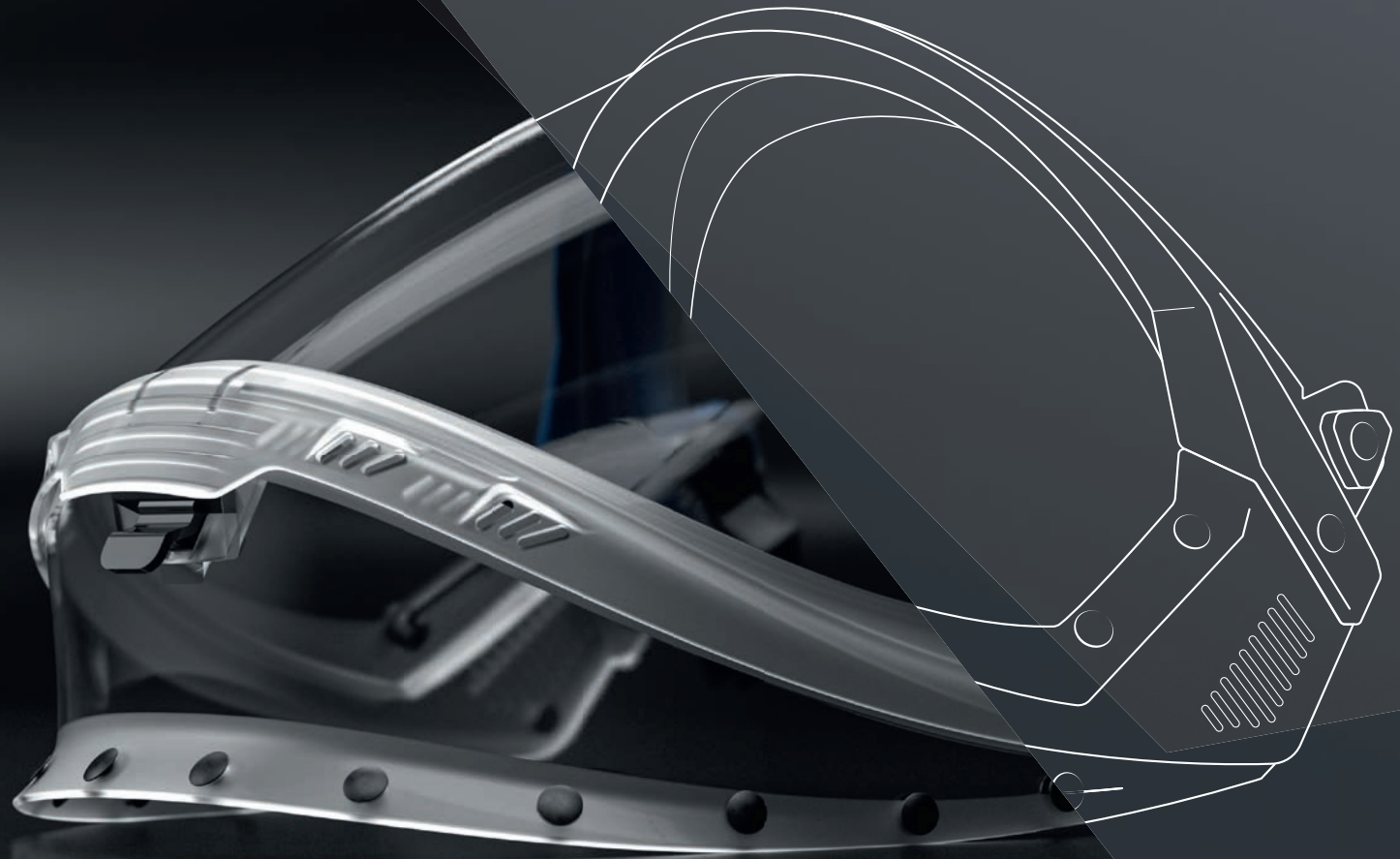

ARC FLASH PPE

Electric Arc Flash is one of the most devastating dangers in the workplace and must be addressed to protect people who may be exposed to this dangerous threat. The potential users of an Arc Shield are not only electrical workers in industry or electrical utilities, in addition, first responders approaching an accident where electricity is involved, could also use an Arc Shield.

The PAULSON Highly Transparent HT™ Arc Shield line uses a proprietary Nanoparticle formulation to absorb the black-body radiation of the Arc Flash while allowing high color perception to ensure the user's vision is not compromised. The Nanoparticle-enhanced HT™ formulation makes the Arc Shield more robust, as the Nanoparticles resist UV light and will not degrade over time. While coatings and films in competitors' Arc Shields are susceptible to scratching and abrasion, which limits the shield's protective ability and service life,

Nanoparticles dispersed throughout the entire thickness of the material are much more resistant to daily wear and tear. This formulation will retain its ability to block Arc Flash radiation over the life of the product.

PAULSON offers numerous Arc Shields and Goggles to satisfy the many different protection requirements of various workplaces. With PAULSON's Arc Flash protective solutions, the user is protected by leading edge Arc Flash PPE, while maximizing the comfort of the user.



AMPSHIELD®

The Highly Transparent HT™ AmpShield® series utilizes our proprietary Nanoparticle formulation for maximum color perception, enhanced reliability and increased durability. Transparent, optically polished chin protectors allow excellent downward vision improving balance and spatial awareness. The AmpShield® is available with three different chin protectors: Medium, XLG and Ergonomic. The AmpShield® also features helmet brackets with the unique LeverLock® mounting system to allow for quick visor replacement. All models are compatible with the PAULSON ALM™ flashlight system.

Helmet Clips

- EURO
- US
- OEM

LeverLock® Mounting System

ALM™
Flashlight System



Standard and Weight-Compensating
Helmet Brackets

Color / ATPV

- White circle
- 12
- 14
- 20
- 25

Coating

- STANDARD
- PREMIUM

Transparent Chin Protector

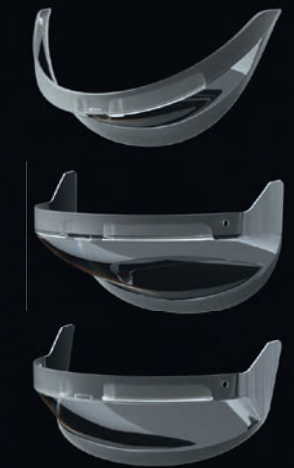

Chin Protector Design

- ANSI Z87.1
- NFPA 70E
- ASTM F2178
- EN 166
- GS-ET-29

KITS AND REPLACEMENT SHIELDS W/ XLG CHIN PROTECTOR

Product Code	Part No.	Description	Material	Color	Standard	ATPV* ⁵	APC* ⁶
AMP1-E6-HT-PCT	9004581	Premium* coated Class 2 AmpShield® w/XLG chin protector and cap bracket (EURO clips)	Polycarbonate, Nylon		EN 166, ANSI Z87.1+, GS-ET-29	∅	2
AMP2-E6-HT	9004582	Premium* coated Class 2 AmpShield® w/XLG chin protector and cap bracket (elastomeric band)	Polycarbonate, Nylon	●	EN 166, ANSI Z87.1+, GS-ET-29	∅	2
AMP-E6-RW-HT	9004583	Premium* coated Class 2 Replacement AmpShield® w/XLG chin protector	Polycarbonate		EN 166, ANSI Z87.1+, GS-ET-29	∅	2
AMP1-E14-HT-PCT	9004818	Premium* coated 14 cal/cm ² AmpShield® w/XLG chin protector and cap bracket (EURO clips)	Polycarbonate, Nylon	●	EN 166, ANSI Z87.1+, GS-ET-29, NFPA 70E, ASTM F2178	14	2
AMP1-E14-HTS-PCT	9004918	Standard* ² coated 14 cal/cm ² AmpShield® w/XLG chin protector and cap bracket (EURO clips)	Polycarbonate, Nylon	●	EN 166, ANSI Z87.1+, GS-ET-29, NFPA 70E, ASTM F2178	14	2
AMP2-E14-HT	9004819	Premium* coated 14 cal/cm ² AmpShield® w/XLG chin protector and cap bracket (elastomeric band)	Polycarbonate, Nylon	●	EN 166, ANSI Z87.1+, GS-ET-29, NFPA 70E, ASTM F2178	14	2
AMP2-E14-HTS	9004921	Standard* ² coated 14 cal/cm ² AmpShield® w/XLG chin protector and cap bracket (elastomeric band)	Polycarbonate, Nylon	●	EN 166, ANSI Z87.1+, GS-ET-29, NFPA 70E, ASTM F2178	14	2
AMP-E14-RW-HT	9004821	Premium* coated 14 cal/cm ² Replacement AmpShield® w/XLG chin protector	Polycarbonate	●	EN 166, ANSI Z87.1+, GS-ET-29, NFPA 70E, ASTM F2178	14	2
AMP-E14-RW-HTS	9004919	Standard* ² coated 14 cal/cm ² Replacement AmpShield® w/XLG chin protector	Polycarbonate	●	EN 166, ANSI Z87.1+, GS-ET-29, NFPA 70E, ASTM F2178	14	2
AMP1-E25-HT-PCT	9004575	Premium* coated 25 cal/cm ² AmpShield® w/XLG chin protector and cap bracket (EURO clips)	Polycarbonate, Nylon	●	EN 166, ANSI Z87.1+, GS-ET-29, NFPA 70E, ASTM F2178	25	2
AMP2-E25-HT	9004576	Premium* coated 25 cal/cm ² AmpShield® w/XLG chin protector and cap bracket (elastomeric band)	Polycarbonate, Nylon	●	EN 166, ANSI Z87.1+, GS-ET-29, NFPA 70E, ASTM F2178	25	2
AMP-E25-RW-HT	9004806	Premium* coated 25 cal/cm ² Replacement AmpShield® w/XLG chin protector	Polycarbonate	●	EN 166, ANSI Z87.1+, GS-ET-29, NFPA 70E, ASTM F2178	25	2

Product Code	Part No.	Description	Material	Color	Standard	ATPV* ⁵	APC* ⁶
AMP1-12-HT	9004585	Premium* coated 12 cal/cm ² AmpShield® w/XLG chin protector and cap bracket (NEW: w/Press-to-Release US clips)	Polycarbonate, Nylon	●	EN 166, ANSI Z87.1+, GS-ET-29, NFPA 70E, ASTM F2178	12	2
AMP2-12-HT	9004563	Premium* coated 12 cal/cm ² AmpShield® w/XLG chin protector and cap bracket (elastomeric band)	Polycarbonate, Nylon	●	EN 166, ANSI Z87.1+, GS-ET-29, NFPA 70E, ASTM F2178	12	2
AMP3-12-HT	9004589	Premium* coated 12 cal/cm ² AmpShield® w/XLG chin protector and hat bracket (elastomeric band) for Full-Brim hats	Polycarbonate, Nylon	●	EN 166* ³ , ANSI Z87.1+, GS-ET-29* ³ , NFPA 70E, ASTM F2178	12	2* ⁷
AMP4-12-HTM	9004942	Premium* coated 12 cal/cm ² AmpShield® w/XLG chin protector and hat bracket (elastomeric band) for MSA® slotted Full-Brim hats	Polycarbonate, Nylon	●	EN 166* ³ , ANSI Z87.1+, GS-ET-29* ³ , NFPA 70E, ASTM F2178	12	2* ⁷
AMP4-12-HTN	9004948	Premium* coated 12 cal/cm ² AmpShield® w/XLG chin protector and hat bracket (elastomeric band) for North® slotted Full-Brim hats	Polycarbonate, Nylon	●	EN 166* ³ , ANSI Z87.1+, GS-ET-29* ³ , NFPA 70E, ASTM F2178	12	2* ⁷
AMP-12-RW-HT	9004592	Premium* coated 12 cal/cm ² Replacement AmpShield® w/XLG chin protector	Polycarbonate	●	EN 166, ANSI Z87.1+, GS-ET-29, NFPA 70E, ASTM F2178	12	2
AMP1-20-HT	9004560	Premium* coated 20 cal/cm ² AmpShield® w/XLG chin protector and cap bracket (NEW: w/Press-to-Release US clips)	Polycarbonate, Nylon	●	EN 166, ANSI Z87.1+, GS-ET-29, NFPA 70E, ASTM F2178	20	2
AMP2-20-HT	9004587	Premium* coated 20 cal/cm ² AmpShield® w/XLG chin protector and cap bracket (elastomeric band)	Polycarbonate, Nylon	●	EN 166, ANSI Z87.1+, GS-ET-29, NFPA 70E, ASTM F2178	20	2
AMP3-20-HT	9004590	Premium* coated 20 cal/cm ² AmpShield® w/XLG chin protector and hat bracket (elastomeric band) for Full-Brim hats	Polycarbonate, Nylon	●	EN 166* ³ , ANSI Z87.1+, GS-ET-29* ³ , NFPA 70E, ASTM F2178	20	2* ⁷
AMP4-20-HTM	9004944	Premium* coated 20 cal/cm ² AmpShield® w/XLG chin protector and hat bracket (elastomeric band) for MSA® slotted Full-Brim hats	Polycarbonate, Nylon	●	EN 166* ³ , ANSI Z87.1+, GS-ET-29* ³ , NFPA 70E, ASTM F2178	20	2* ⁷
AMP4-20-HTN	9004950	Premium* coated 20 cal/cm ² AmpShield® w/XLG chin protector and hat bracket (elastomeric band) for North® slotted Full-Brim hats	Polycarbonate, Nylon	●	EN 166* ³ , ANSI Z87.1+, GS-ET-29* ³ , NFPA 70E, ASTM F2178	20	2* ⁷
AMP-20-RW-HT	9004577	Premium* coated 20 cal/cm ² Replacement AmpShield® w/XLG chin protector	Polycarbonate	●	EN 166, ANSI Z87.1+, GS-ET-29, NFPA 70E, ASTM F2178	20	2

KITS AND REPLACEMENT SHIELDS W/ERGONOMIC CHIN PROTECTOR

Product Code	Part No.	Description	Material	Color	Standard	ATPV* ⁵	APC* ⁶
AMP1-E6-HT-PCT-EC	9103007	Premium* coated Class 2 AmpShield® w/Ergonomic chin protector and cap bracket (EURO clips)	Polycarbonate, Nylon		EN 166, ANSI Z87.1+, GS-ET-29	∅	2
AMP2-E6-HT-EC	9103008	Premium* coated Class 2 AmpShield® w/Ergonomic chin protector and cap bracket (elastomeric band)	Polycarbonate, Nylon	●	EN 166, ANSI Z87.1+, GS-ET-29	∅	2
AMP-E6-RW-HT-EC	9103009	Premium* coated Class 2 Replacement AmpShield® w/Ergonomic chin protector	Polycarbonate		EN 166, ANSI Z87.1+, GS-ET-29	∅	2
AMP1-E14-HT-PCT-EC	9103012	Premium* coated 14 cal/cm ² AmpShield® w/Ergonomic chin protector and cap bracket (EURO clips)	Polycarbonate, Nylon	●	EN 166, ANSI Z87.1+, GS-ET-29, NFPA 70E, ASTM F2178	14	2
AMP1-E14-HTS-PCT-EC	9103013	Standard* ² coated 14 cal/cm ² AmpShield® w/Ergonomic chin protector and cap bracket (EURO clips)	Polycarbonate, Nylon	●	EN 166, ANSI Z87.1+, GS-ET-29, NFPA 70E, ASTM F2178	14	2
AMP2-E14-HT-EC	9103006	Premium* coated 14 cal/cm ² AmpShield® w/Ergonomic chin protector and cap bracket (elastomeric band)	Polycarbonate, Nylon	●	EN 166, ANSI Z87.1+, GS-ET-29, NFPA 70E, ASTM F2178	14	2
AMP2-E14-HTS-EC	9103005	Standard* ² coated 14 cal/cm ² AmpShield® w/Ergonomic chin protector and cap bracket (elastomeric band)	Polycarbonate, Nylon	●	EN 166, ANSI Z87.1+, GS-ET-29, NFPA 70E, ASTM F2178	14	2
AMP-E14-RW-HT-EC	9103023	Premium* coated 14 cal/cm ² Replacement AmpShield® w/Ergonomic chin protector	Polycarbonate	●	EN 166, ANSI Z87.1+, GS-ET-29, NFPA 70E, ASTM F2178	14	2
AMP-E14-RW-HTS-EC	9103014	Standard* ² coated 14 cal/cm ² Replacement AmpShield® w/Ergonomic chin protector	Polycarbonate	●	EN 166, ANSI Z87.1+, GS-ET-29, NFPA 70E, ASTM F2178	14	2
AMP1-E25-HT-PCT-EC	9103020	Premium* coated 25 cal/cm ² AmpShield® w/Ergonomic chin protector and cap bracket (EURO clips)	Polycarbonate, Nylon	●	EN 166, ANSI Z87.1+, GS-ET-29, NFPA 70E, ASTM F2178	25	2
AMP2-E25-HT-EC	9103021	Premium* coated 25 cal/cm ² AmpShield® w/Ergonomic chin protector and cap bracket (elastomeric band)	Polycarbonate, Nylon	●	EN 166, ANSI Z87.1+, GS-ET-29, NFPA 70E, ASTM F2178	25	2
AMP-E25-RW-HT-EC	9103022	Premium* coated 25 cal/cm ² Replacement AmpShield® w/Ergonomic chin protector	Polycarbonate	●	EN 166, ANSI Z87.1+, GS-ET-29, NFPA 70E, ASTM F2178	25	2
AMP1-12-HT-EC	9008901	Premium* coated 12 cal/cm ² AmpShield® w/Ergonomic chin protector and cap bracket (NEW: w/Press-to-Release US clips)	Polycarbonate, Nylon	●	EN 166, ANSI Z87.1+, GS-ET-29, NFPA 70E, ASTM F2178	12	2
AMP1-12HT-W	9131001	Premium* coated 12 cal/cm ² AmpShield® w/Ergonomic chin protector and weight-compensating bracket with Press-to-Release US clips	Polycarbonate, Nylon	●	EN 166, ANSI Z87.1+, GS-ET-29, NFPA 70E, ASTM F2178	12	2

NEW

Product Code	Part No.	Description	Material	Color	Standard	ATPV*5	APC*6	
AMP1-12HT-P	9132001	Premium* coated 12 cal/cm ² AmpShield® w/Ergonomic chin protector and weight compensating bracket for Petzl® safety helmets	Polycarbonate	●	EN 166*3, ANSI Z87.1+, GS-ET-29*3, NFPA 70E, ASTM F2178	12	2	NEW
AMP1-12HT-K	9133001	Premium* coated 12 cal/cm ² AmpShield® w/Ergonomic chin protector and weight compensating bracket for KASK® safety helmets	Polycarbonate	●	EN 166*3, ANSI Z87.1+, GS-ET-29*3, NFPA 70E, ASTM F2178	12	2	NEW
AMP1-12HT-B	9135001	Premium* coated 12 cal/cm ² AmpShield® w/Ergonomic chin protector and weight compensating bracket for Bullard® safety helmets	Polycarbonate	●	EN 166*3, ANSI Z87.1+, GS-ET-29*3, NFPA 70E, ASTM F2178	12	2	NEW
AMP1-12HT-3M	9131011	Premium* coated 12 cal/cm ² AmpShield® w/Ergonomic chin protector and weight compensating bracket for 3M® safety helmets	Polycarbonate	●	EN 166*3, ANSI Z87.1+, GS-ET-29*3, NFPA 70E, ASTM F2178	12	2	NEW
AMP1-12HT-M	9132011	Premium* coated 12 cal/cm ² AmpShield® w/Ergonomic chin protector and weight compensating bracket for MSA® safety helmets	Polycarbonate	●	EN 166*3, ANSI Z87.1+, ASTM 2178, NFPA 70E	12	2	NEW
AMP1-12-HTS-EC	9009910	Standard*2 coated 12 cal/cm ² AmpShield® w/Ergonomic chin protector and cap bracket (NEW: w/Press-to-Release US clips)	Polycarbonate, Nylon	●	EN 166, ANSI Z87.1+, GS-ET-29, NFPA 70E, ASTM F2178	12	2	
AMP1-12HTS-W	9131000	Standard*2 coated 12 cal/cm ² AmpShield® w/Ergonomic chin protector and weight-compensating bracket with Press-to-Release US clips	Polycarbonate, Nylon	●	EN 166, ANSI Z87.1+, GS-ET-29, NFPA 70E, ASTM F2178	12	2	NEW
AMP1-12HTS-P	9132000	Standard*2 coated 12 cal/cm ² AmpShield® w/Ergonomic chin protector and weight compensating bracket for Petzl® safety helmets	Polycarbonate	●	EN 166*3, ANSI Z87.1+, GS-ET-29*3, NFPA 70E, ASTM F2178	12	2	NEW
AMP1-12HTS-K	9133000	Standard*2 coated 12 cal/cm ² AmpShield® w/Ergonomic chin protector and weight compensating bracket for KASK® safety helmets	Polycarbonate	●	EN 166*3, ANSI Z87.1+, GS-ET-29*3, NFPA 70E, ASTM F2178	12	2	NEW
AMP1-12HTS-B	9135000	Standard*2 coated 12 cal/cm ² AmpShield® w/Ergonomic chin protector and weight compensating bracket for Bullard® safety helmets	Polycarbonate	●	EN 166*3, ANSI Z87.1+, GS-ET-29*3, NFPA 70E, ASTM F2178	12	2	NEW
AMP1-12HTS-3M	9131010	Standard*2 coated 12 cal/cm ² AmpShield® w/Ergonomic chin protector and weight compensating bracket for 3M® safety helmets	Polycarbonate	●	EN 166*3, ANSI Z87.1+, GS-ET-29*3, NFPA 70E, ASTM F2178	12	2	NEW
AMP1-12HTS-M	9132010	Standard*2 coated 12 cal/cm ² AmpShield® w/Ergonomic chin protector and weight compensating bracket for MSA® safety helmets	Polycarbonate	●	EN 166*3, ANSI Z87.1+, GS-ET-29*3, NFPA 70E, ASTM F2178	12	2	NEW
AMP2-12-HT-EC	9103000	Premium* coated 12 cal/cm ² AmpShield® w/Ergonomic chin protector and cap bracket (elastomeric band)	Polycarbonate, Nylon	●	EN 166, ANSI Z87.1+, GS-ET-29, NFPA 70E, ASTM F2178	12	2	
AMP2-12-HTS-EC	9103003	Standard*2 coated 12 cal/cm ² AmpShield® w/Ergonomic chin protector and cap bracket (elastomeric band)	Polycarbonate, Nylon	●	EN 166, ANSI Z87.1+, GS-ET-29, NFPA 70E, ASTM F2178	12	2	

KITS AND REPLACEMENT SHIELDS W/ERGONOMIC CHIN PROTECTOR



Product Code	Part No.	Description	Material	Color	Standard	ATPV*5	APC*6	
AMP3-12-HT-EC	9103035	Premium* coated 12 cal/cm ² AmpShield® w/Ergonomic chin protector and hat bracket (elastomeric band) for Full-Brim hats	Polycarbonate, Nylon	●	EN 166*3, ANSI Z87.1+, GS-ET-29*3, NFPA 70E, ASTM F2178	12	2*7	
AMP3-12-HTS-EC	9103036	Standard*2 coated 12 cal/cm ² AmpShield® w/Ergonomic chin protector and hat bracket (elastomeric band) for Full-Brim hats	Polycarbonate, Nylon	●	EN 166*3, ANSI Z87.1+, GS-ET-29*3, NFPA 70E, ASTM F2178	12	2*7	
AMP4-12HT-ECM	9004943	Premium* coated 12 cal/cm ² AmpShield® w/Ergonomic chin protector and hat bracket (elastomeric band) for MSA® slotted Full-Brim hats	Polycarbonate, Nylon	●	EN 166*3, ANSI Z87.1+, GS-ET-29*3, NFPA 70E, ASTM F2178	12	2*7	
AMP4-12HTS-ECM	9004941	Standard*2 coated 12 cal/cm ² AmpShield® w/Ergonomic chin protector and hat bracket (elastomeric band) for MSA® slotted Full-Brim hats	Polycarbonate, Nylon	●	EN 166*3, ANSI Z87.1+, GS-ET-29*3, NFPA 70E, ASTM F2178	12	2*7	
AMP4-12HT-ECN	9004949	Premium* coated 12 cal/cm ² AmpShield® w/Ergonomic chin protector and hat bracket (elastomeric band) for North® slotted Full-Brim hats	Polycarbonate, Nylon	●	EN 166*3, ANSI Z87.1+, GS-ET-29*3, NFPA 70E, ASTM F2178	12	2*7	
AMP4-12HTS-ECN	9004947	Standard*2 coated 12 cal/cm ² AmpShield® w/Ergonomic chin protector and hat bracket (elastomeric band) for North® slotted Full-Brim hats	Polycarbonate, Nylon	●	EN 166*3, ANSI Z87.1+, GS-ET-29*3, NFPA 70E, ASTM F2178	12	2*7	
AMP-12-RW-HT-EC	9009912	Premium* coated 12 cal/cm ² Replacement AmpShield® w/Ergonomic chin protector	Polycarbonate	●	EN 166, ANSI Z87.1+, GS-ET-29, NFPA 70E, ASTM F2178	12	2	
AMP-12-RW-HTS-EC	9004672	Standard*2 coated 12 cal/cm ² Replacement AmpShield® w/Ergonomic chin protector	Polycarbonate	●	EN 166, ANSI Z87.1+, GS-ET-29, NFPA 70E, ASTM F2178	12	2	
AMP1-20-HT-EC	9008905	Premium* coated 20 cal/cm ² AmpShield® w/Ergonomic chin protector and cap bracket (NEW: w/Press-to-Release US clips)	Polycarbonate, Nylon	●	EN 166, ANSI Z87.1+, GS-ET-29, NFPA 70E, ASTM F2178	20	2	NEW
AMP1-20HT-W	9131002	Premium* coated 20 cal/cm ² AmpShield® w/Ergonomic chin protector and weight-compensating bracket with Press-to-Release US clips	Polycarbonate, Nylon	●	EN 166, ANSI Z87.1+, GS-ET-29, NFPA 70E, ASTM F2178	12	2	NEW
AMP1-20HT-P	9132002	Premium* coated 20 cal/cm ² AmpShield® w/Ergonomic chin protector and weight compensating bracket for Petzl® safety helmets	Polycarbonate	●	EN 166*3, ANSI Z87.1+, GS-ET-29*3, NFPA 70E, ASTM F2178	20	2	NEW
AMP1-20HT-K	9133002	Premium* coated 20 cal/cm ² AmpShield® w/Ergonomic chin protector and weight compensating bracket for KASK® safety helmets	Polycarbonate	●	EN 166*3, ANSI Z87.1+, GS-ET-29*3, NFPA 70E, ASTM F2178	20	2	NEW
AMP1-20HT-B	9135002	Premium* coated 20 cal/cm ² AmpShield® w/Ergonomic chin protector and weight compensating bracket for Bullard® safety helmets	Polycarbonate	●	EN 166*3, ANSI Z87.1+, GS-ET-29*3, NFPA 70E, ASTM F2178	20	2	NEW
AMP1-20HT-3M	9131012	Premium* coated 20 cal/cm ² AmpShield® w/Ergonomic chin protector and weight compensating bracket for 3M® safety helmets	Polycarbonate	●	EN 166*3, ANSI Z87.1+, GS-ET-29*3, NFPA 70E, ASTM F2178	20	2	NEW

Product Code	Part No.	Description	Material	Color	Standard	ATPV* ⁵	APC* ⁶
AMP1-20HT-M	9132012	Premium* coated 20 cal/cm ² AmpShield® w/Ergonomic chin protector and weight compensating bracket for MSA® safety helmets	Polycarbonate	●	EN 166* ³ , ANSI Z87.1+, GS-ET-29* ³ , NFPA 70E, ASTM F2178	20	2
AMP2-20-HT-EC	9103001	Premium* coated 20 cal/cm ² AmpShield® w/Ergonomic chin protector and cap bracket (elastomeric band)	Polycarbonate, Nylon	●	EN 166, ANSI Z87.1+, GS-ET-29, NFPA 70E, ASTM F2178	20	2
AMP3-20-HT-EC	9103037	Premium* coated 20 cal/cm ² AmpShield® w/Ergonomic chin protector and hat bracket (elastomeric band) for Full-Brim hats	Polycarbonate, Nylon	●	EN 166* ³ , ANSI Z87.1+, GS-ET-29* ³ , NFPA 70E, ASTM F2178	20	2* ⁷
AMP4-20HT-ECM	9004945	Premium* coated 20 cal/cm ² AmpShield® w/Ergonomic chin protector and hat bracket (elastomeric band) for MSA® slotted Full-Brim hats	Polycarbonate, Nylon	●	EN 166* ³ , ANSI Z87.1+, GS-ET-29* ³ , NFPA 70E, ASTM F2178	20	2* ⁷
AMP4-20HT-ECN	9004951	Premium* coated 20 cal/cm ² AmpShield® w/Ergonomic chin protector and hat bracket (elastomeric band) for North® slotted Full-Brim hats	Polycarbonate, Nylon	●	EN 166* ³ , ANSI Z87.1+, GS-ET-29* ³ , NFPA 70E, ASTM F2178	20	2* ⁷
AMP-20-RW-HT-EC	9009913	Premium* coated 20 cal/cm ² Replacement AmpShield® w/Ergonomic chin protector	Polycarbonate	●	EN 166, ANSI Z87.1+, GS-ET-29, NFPA 70E, ASTM F2178	20	2







KITS AND REPLACEMENT SHIELDS W/MEDIUM CHIN PROTECTOR

Product Code	Part No.	Description	Material	Color	Standard	ATPV* ⁵	APC* ⁶
AMP1-12-HTS	9004584	Standard* ² coated 12 cal/cm ² AmpShield® w/Medium chin protector and cap bracket (NEW: w/Press-to-Release US clips)	Polycarbonate, Nylon	●	EN 166, ANSI Z87.1+, GS-ET-29, NFPA 70E, ASTM F2178	12	2
AMP2-12-HTS	9004586	Standard* ² coated 12 cal/cm ² AmpShield® w/Medium chin protector and cap bracket (elastomeric band)	Polycarbonate, Nylon	●	EN 166, ANSI Z87.1+, GS-ET-29, NFPA 70E, ASTM F2178	12	2
AMP3-12-HTS	9004588	Standard* ² coated 12 cal/cm ² AmpShield® w/Medium chin protector and hat bracket (elastomeric band) for Full-Brim hats	Polycarbonate, Nylon	●	EN 166* ³ , ANSI Z87.1+, GS-ET-29* ³ , NFPA 70E, ASTM F2178	12	2* ⁷
AMP4-12-HTSM	9004940	Standard* ² coated 12 cal/cm ² AmpShield® w/Medium chin protector and hat bracket (elastomeric band) for MSA® slotted Full-Brim hats	Polycarbonate, Nylon	●	EN 166* ³ , ANSI Z87.1+, GS-ET-29* ³ , NFPA 70E, ASTM F2178	12	2* ⁷
AMP4-12-HTSN	9004946	Standard* ² coated 12 cal/cm ² AmpShield® w/Medium chin protector and hat bracket (elastomeric band) for North® slotted Full-Brim hats	Polycarbonate, Nylon	●	EN 166* ³ , ANSI Z87.1+, GS-ET-29* ³ , NFPA 70E, ASTM F2178	12	2* ⁷
AMP-12-RW-HTS	9004591	Standard* coated 12 cal/cm ² Replacement AmpShield® w/Medium chin protector	Polycarbonate	●	EN 166, ANSI Z87.1+, GS-ET-29, NFPA 70E, ASTM F2178	12	2



HELMET BRACKETS

Product Code	Part No.	Description	Material	Color	Standard	ATPV*5	APC*6	
AMP-CS	9004504	High Temp AmpShield® Cap Bracket for slotted caps w/NEW Press-to-Release US clips	Nylon		EN 166*4, ANSI Z87.1+, GS-ET-29*4, NFPA 70E*4, ASTM F2178*4	n/a	2*8	
AMP-CS-CT	9004506	High Temp AmpShield® Cap Bracket for slotted caps w/EURO clips	Nylon		EN 166*4, ANSI Z87.1+, GS-ET-29*4, NFPA 70E*4, ASTM F2178*4	n/a	2*8	
AMP-CU	9004505	High Temp AmpShield® Cap Bracket for slotted/un-slotted caps w/elastomeric band	Nylon		EN 166*4, ANSI Z87.1+, GS-ET-29*4, NFPA 70E*4, ASTM F2178*4	n/a	2*8	
AMP-CH	9004527	High Temp AmpShield® Hat Bracket for slotted/un-slotted hats w/elastomeric band	Nylon		EN 166*4, ANSI Z87.1+, GS-ET-29*4, NFPA 70E*4, ASTM F2178*4	n/a	2*8	
AMP-CHSM	9004952	High Temp AmpShield® Hat Bracket w/elastomeric band for MSA® slotted Full-Brim hats	Nylon		EN 166*4, ANSI Z87.1+, GS-ET-29*4, NFPA 70E*4, ASTM F2178*4	n/a	2*8	NEW
AMP-CHSN	9004594	High Temp AmpShield® Hat Bracket w/elastomeric band for North® slotted Full-Brim hats	Nylon		EN 166*4, ANSI Z87.1+, GS-ET-29*4, NFPA 70E*4, ASTM F2178*4	n/a	2*8	NEW





WEIGHT COMPENSATING BRACKETS

Product Code	Part No.	Description	Material	Color	Standard	ATPV*5	APC*6	
WCB-AMP-CS	9142022	AmpShield® weight-compensating cap bracket w/NEW Press-to-Release US clips for slotted caps	Nylon		EN 166*4, ANSI Z87.1+, GS-ET-29*4, NFPA 70E*4, ASTM F2178*4	n/a	2*8	NEW
WCB-AMP-3M	9142070	AmpShield® weight-compensating cap bracket w/NEW Press-to-Release clips for slotted 3M® safety helmets	Nylon		EN 166*4, ANSI Z87.1+, GS-ET-29*4, NFPA 70E*4, ASTM F2178*4	n/a	2*8	NEW
WCB-AMP-B	9142050	AmpShield® weight-compensating cap bracket w/NEW Press-to-Release clips for slotted Bullard® safety helmets	Nylon		EN 166*4, ANSI Z87.1+, GS-ET-29*4, NFPA 70E*4, ASTM F2178*4	n/a	2*8	NEW
WCB-AMP-K	9142040	AmpShield® weight-compensating cap bracket w/NEW Press-to-Release clips for slotted KASK® safety helmets	Nylon		EN 166*4, ANSI Z87.1+, GS-ET-29*4, NFPA 70E*4, ASTM F2178*4	n/a	2*8	NEW
WCB-AMP-M	914080	AmpShield® weight-compensating cap bracket w/NEW Press-to-Release clips for slotted MSA® safety helmets	Nylon		EN 166*4, ANSI Z87.1+, GS-ET-29*4, NFPA 70E*4, ASTM F2178*4	n/a	2*8	NEW
WCB-AMP-P	914030	AmpShield® weight-compensating cap bracket w/NEW Press-to-Release clips for slotted Petzl® safety helmets	Nylon		EN 166*4, ANSI Z87.1+, GS-ET-29*4, NFPA 70E*4, ASTM F2178*4	n/a	2*8	NEW

REPLACEMENT CLIPS

Product Code	Part No.	Description	Material	Color	Standard	ATPV* ⁵	APC* ⁶
CBA-CT	9004869	EURO clips* ⁹	Nylon		EN 166, ANSI Z87.1+, GS-ET-29* ⁴ , NFPA 70E* ⁴ , ASTM F2178* ⁴	n/a	2* ⁸
A-TPH	1603900	Replacement kit of screws, washers and knobs	Nylon		EN 166, ANSI Z87.1+, GS-ET-29* ⁴ , NFPA 70E* ⁴ , ASTM F2178* ⁴	n/a	2* ⁸

FLASHLIGHT

Product Code	Part No.	Description	Material	Color	Standard	ATPV* ⁵	APC* ⁶
3P-FL	9041600	Flashlight	Thermoplastic, Polycarbonate, LED		NFPA 70E, ANSI/NEMA FL1-2009	100	2
3P-FL-ALM-KIT	9041602	Flashlight w/Articulated Light Mount kit	Plastic Alloy, Thermoplastic, Polycarbonate, LED		NFPA 70E, ANSI/NEMA FL1-2009	100	2
3P-FL CE	9041604	CE certified Flashlight	Thermoplastic, Polycarbonate, LED		NFPA 70E, EN 61000-6-1:2016, EN 61000-6-3:2007 +A1:2011; GS-ET-29:2011, ANSI/NEMA FL1-2009	100	2
3P-FL-ALM-KIT CE	9041603	CE certified Flashlight w/Articulated Light Mount kit	Plastic Alloy, Thermoplastic, Polycarbonate, LED		NFPA 70E, EN 61000-6-1:2016, EN 61000-6-3:2007 +A1:2011; GS-ET-29:2011, ANSI/NEMA FL1-2009	100	2
3P-ALM	9041601	Articulated Light Mount	Plastic Alloy		NFPA 70E	100	2

* Anti-abrasion Hard Coating (outside) plus permanent Anti-fog Coating (inside)

*² Non-permanent Anti-fog Coating

*³ designed to meet EN 166 and GS-ET-29

*⁴ in combination w/AmpShield®

*⁵ Arc Thermal Performance Value as per ASTM F2178, measured in cal/cm²

*⁶ Arc Protection Class (APC) as per GS-ET-29

*⁷ designed to meet APC 2

*⁸ designed to meet APC 2, when combined w/AmpShield®

*⁹ custom clips on special request

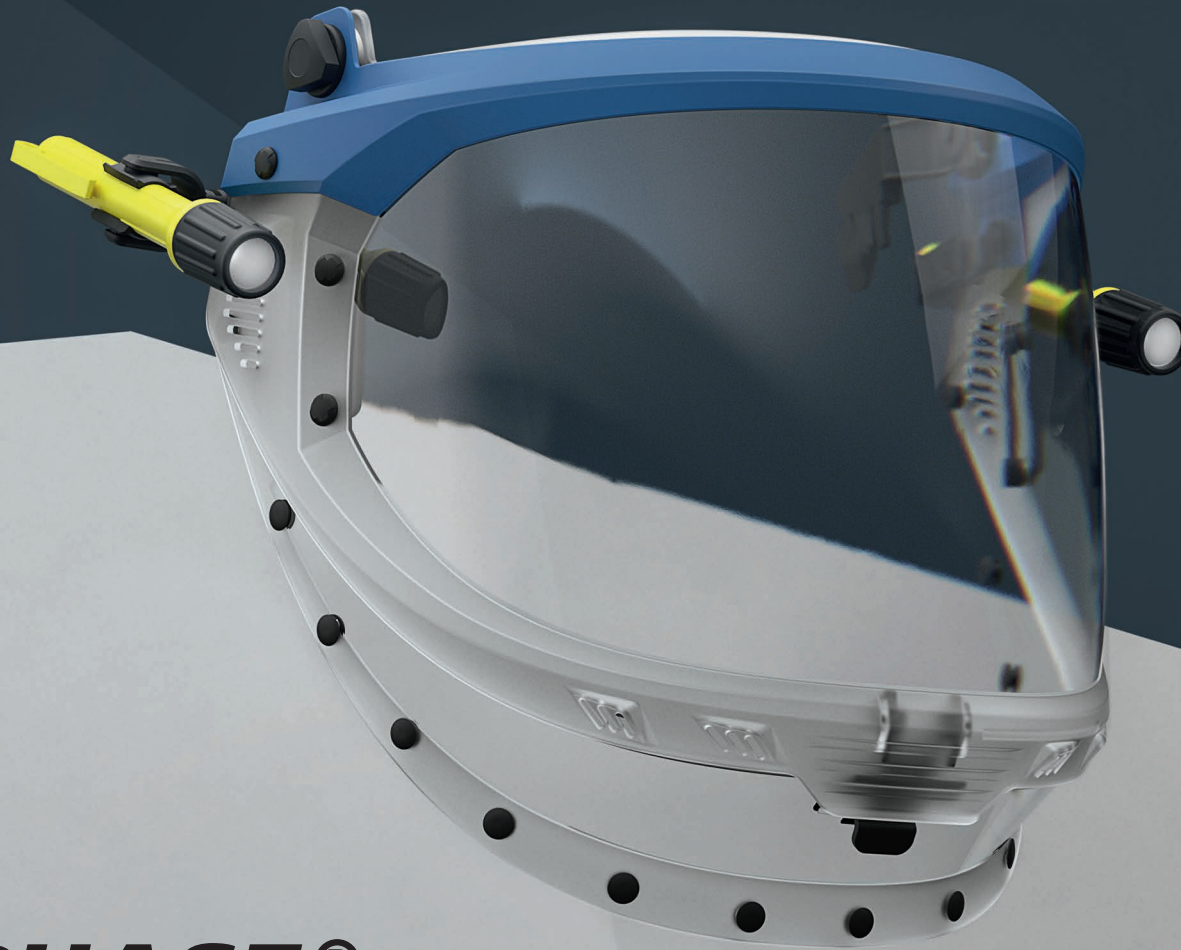

3PHASE®

The 3Phase® series consists of Highly Transparent HT™ lift-front Arc Shields for Hood and Shroud assemblies. The lift-front concept allows the user to open the Arc Shield for communication and ventilation, when out of the work zone, without taking off the complete Hood or Shroud. The 3Phase® also does not require the use of a Balaclava underneath the Arc Shield, improving comfort, especially in hot weather.

Other unique features of the 3Phase® include an optically corrected toric lens with a wide field of view, air vents and auditory ports, plus an integrated transparent chin protector providing an unrivaled look and feel to the user. For increased ventilation and auditory awareness for the user, use the unique PAULSON ArcVent™, which can be sewn into the Arc Flash Hood or Shroud.

Helmet Clips

US OEM

ALM™
Flashlight System



Auditory Ports

Toric Lens

ArcVent™



Transparent Chin Protector



Hood and Shroud Compatibility

Color / ATPV

12 20 40 75 100

Coating

PREMIUM

Air Vents

Riveted Velcro® Attachment

ANSI Z87.1

NFPA 70E

ASTM F2178

EN 166

GS-ET-29

SHROUD MODELS

Product Code	Part No.	Description	Material	Color	Standard	ATPV*3	APC*5
3P12-S	9014000	Premium* coated 12 cal/cm ² 3Phase® Lift-Front Arc Shield for shrouds	Polycarbonate, Nylon	●	ANSI Z87.1+, ASTM F2178, NFPA 70E, GS-ET-29*2	12*4	2*6
3P20-S	9024000	Premium* coated 20 cal/cm ² 3Phase® Lift-Front Arc Shield for shrouds	Polycarbonate, Nylon	●	ANSI Z87.1+, ASTM F2178, NFPA 70E, EN 166, GS-ET-29*2	20*4	2*7
3P40-S	9044000	Premium* coated 40 cal/cm ² 3Phase® Lift-Front Arc Shield for shrouds	Polycarbonate, Nylon	●	ANSI Z87.1+, ASTM F2178, NFPA 70E, EN 166, GS-ET-29*2	40*4	2*7

HOOD MODELS

Product Code	Part No.	Description	Material	Color	Standard	ATPV*3	APC*5
3P12-H	9015000	Premium* coated 12 cal/cm ² 3Phase® Lift-Front Arc Shield for hoods	Polycarbonate, Nylon	●	ANSI Z87.1+, ASTM F2178, NFPA 70E, GS-ET-29*2	12*4	2*6
3P20-H	9025000	Premium* coated 20 cal/cm ² 3Phase® Lift-Front Arc Shield for hoods	Polycarbonate, Nylon	●	ANSI Z87.1+, ASTM F2178, NFPA 70E, EN 166, GS-ET-29*2	20*4	2*7
3P40-H	9045000	Premium* coated 40 cal/cm ² 3Phase® Lift-Front Arc Shield for hoods	Polycarbonate, Nylon	●	ANSI Z87.1+, ASTM F2178, NFPA 70E, EN 166, GS-ET-29*2	40*4	2*7
3P75-H	9045075	Premium* coated 75 cal/cm ² 3Phase® Lift-Front Arc Shield for hoods w/Cold Weather Lens	Polycarbonate, Nylon	●	ANSI Z87.1+, ASTM F2178, NFPA 70E, EN 166, GS-ET-29*2	75*4	2*7
3P100-H	9045100	Premium* coated 100 cal/cm ² 3Phase® Lift-Front Arc Shield for hoods w/Cold Weather Lens	Polycarbonate, Nylon	●	ANSI Z87.1+, ASTM F2178, NFPA 70E, EN 166, GS-ET-29*2	100*4	2*7





REPLACEMENT SHIELDS

Product Code	Part No.	Description	Material	Color	Standard	ATPV*3	APC*5
3P12-RW	9046001	Premium* coated 3Phase® Lift-Front Replacement Arc Shield 12 cal/cm ²	Polycarbonate, Nylon	●	ANSI Z87.1+, ASTM F2178, NFPA 70E, GS-ET-29*2	12*4	2*6
3P20-RW	9025220	Premium* coated 3Phase® Lift-Front Replacement Arc Shield 20 cal/cm ²	Polycarbonate, Nylon	●	ANSI Z87.1+, ASTM F2178, NFPA 70E, EN 166, GS-ET-29*2	20*4	2*7
3P40-RW	9025330	Premium* coated 3Phase® Lift-Front Replacement Arc Shield 40 cal/cm ²	Polycarbonate, Nylon	●	ANSI Z87.1+, ASTM F2178, NFPA 70E, EN 166, GS-ET-29*2	40*4	2*7
3P75-RW	9046002	Premium* coated 3Phase® Lift-Front Replacement Arc Shield 75 cal/cm ²	Polycarbonate, Nylon	●	ANSI Z87.1+, ASTM F2178, NFPA 70E, EN 166, GS-ET-29*2	75*4	2*7
3P100-RW	9046003	Premium* coated 3Phase® Lift-Front Replacement Arc Shield 100 cal/cm ²	Polycarbonate, Nylon	●	ANSI Z87.1+, ASTM F2178, NFPA 70E, EN 166, GS-ET-29*2	100*4	2*7
3P-CWL	9041001	Cold Weather Lens	Polycarbonate	○	ANSI Z87.1+, ASTM F2178, NFPA 70E, GS-ET-29*2	100*4	2*6



REPLACEMENT CLIPS

Product Code	Part No.	Description	Material	Color	Standard	ATPV*3	APC*5
3P-HAC Clips	9018906	3Phase® Helmet Clip Adapter Set (right and left)*8	Nylon	●	ANSI Z87.1+, ASTM F2178, NFPA 70E, EN 166, GS-ET-29*2	n/a	2*6
3P-Pivot Kit	9014070	3Phase® Pivot Screws and Nuts, Detent and Friction Washers (2 units each)	Nylon	●	ANSI Z87.1+, ASTM F2178, NFPA 70E, EN 166, GS-ET-29*2	n/a	2*6

FLASHLIGHT

Product Code	Part No.	Description	Material	Color	Standard	ATPV*3	APC*5
3P-FL	9041600	Flashlight	Flame-retardant plastic, Polycarbonate, LED		NFPA 70E, ANSI/NEMA FL1-2009	100	2*6
3P-FL-ALM-KIT	9041602	Flashlight w/Articulated Light Mount kit	Flame-retardant plastic, Polycarbonate, LED		NFPA 70E, ANSI/NEMA FL1-2009	100	2*6
3P-FL CE	9041604	CE certified Flashlight	Flame-retardant plastic, Polycarbonate, LED		NFPA 70E, EN 61000-6-1:2016, EN 61000-6-3:2007 +A1:2011; GS-ET-29:2011, ANSI/NEMA FL1-2009	100	2*6
3P-FL-ALM-KIT CE	9041603	CE certified Flashlight w/Articulated Light Mount kit	Flame-retardant plastic, Polycarbonate, LED		NFPA 70E, EN 61000-6-1:2016, EN 61000-6-3:2007 +A1:2011; GS-ET-29:2011, ANSI/NEMA FL1-2009	100	2*6
3P-ALM	9041601	Articulated Light Mount	Plastic Alloy		NFPA 70E	100	2*6

ARCVENT™

Product Code	Part No.	Description	Material	Color	Standard	ATPV*3	APC*5
AV-O	9080000	Octagonal ArcVent™	Flame-Retardant Elastomer		ASTM F2178, NFPA 70E, EN 166, GS-ET-29*2	100*4	2*6
AV-H	9080002	Hexagonal ArcVent™	Flame-Retardant Elastomer		ASTM F2178, NFPA 70E, EN 166, GS-ET-29*2	100*4	2*6
AV-R	9080001	Rectangular ArcVent™	Flame-Retardant Elastomer		ASTM F2178, NFPA 70E, EN 166, GS-ET-29*2	100*4	2*6

* Anti-abrasion Hard Coating (outside) plus permanent Anti-fog Coating (inside)

*2 designed to meet specific standards, when combined w/Arc Flash Hood or Shroud

*3 Arc Thermal Performance Value as per ASTM F2178, measured in cal/cm²

*4 possible ATPV, when combined w/Arc Flash Hood or Shroud

*5 Arc Protection Class (APC) as per GS-ET-29

*6 possible APC, when combined w/Arc Flash Hood or Shroud

*7 tested and certified as stand-alone product, and designed to meet APC 2, when combined w/Arc Flash Hood or Shroud

*8 custom clips on special request



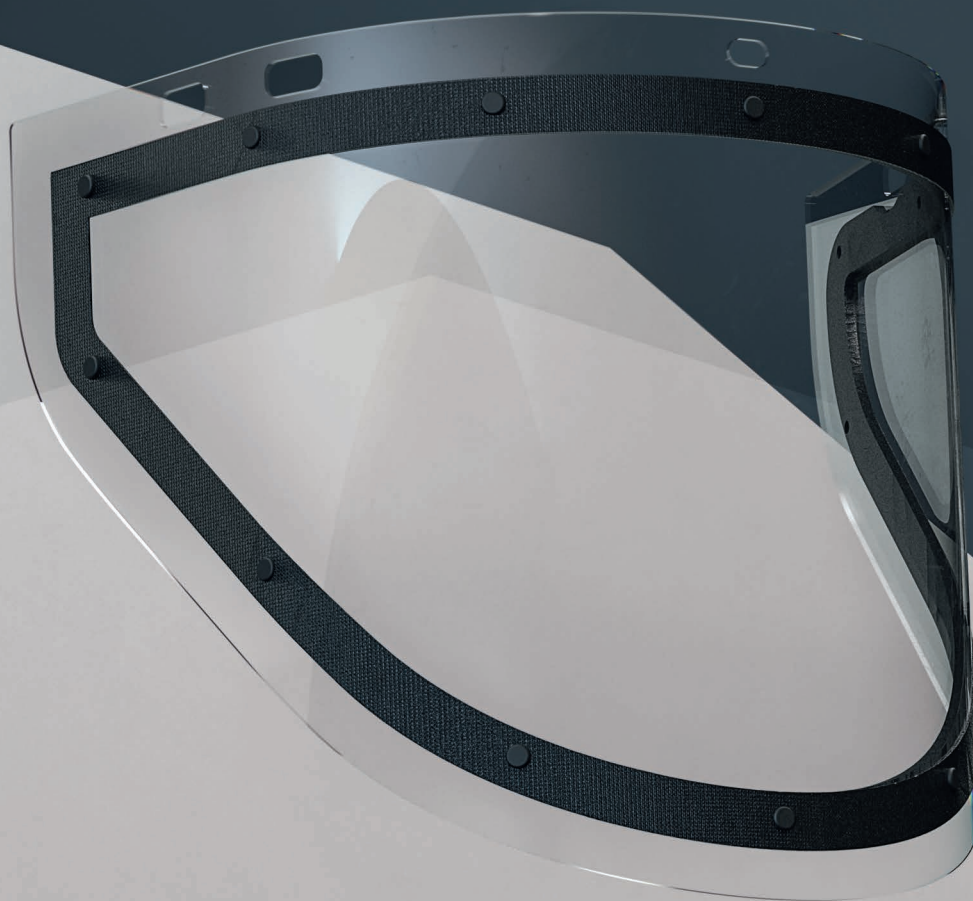

ARC SHIELDS FOR HOODS

The Highly Transparent HT™ Arc Shields for Hoods are intended to be paired with Arc Flash Hoods of equal or greater calorie rating up to 100 cal/cm². All Arc Shields for Hoods are injection molded with an optically corrected lens. They are Premium coated and come with dielectric rivets for a secure Velcro® attachment. For indirect ventilation in your Arc Flash Hood, use the ArcVent™.

Helmet Clips

- EURO
- US
- OEM

Lens Design



ArcVent™



Helmet Brackets



Color / ATPV

- 12
- 25
- 40
- 75
- 100

Coating

PREMIUM

Riveted Velcro® Attachment

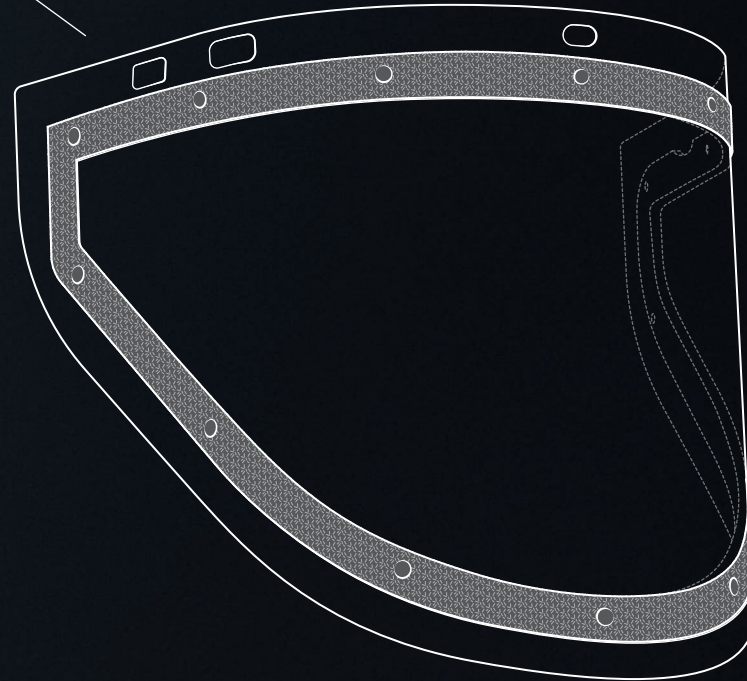

ANSI Z87.1

NFPA 70E

ASTM F2178



EN 166

GS-ET-29



SINGLE LENS MODELS

Product Code	Part No.	Description	Material	Color	Standard	ATPV*4	APC*6
IM22-AFA-25-V-HT	2190753	Premium* coated 25 cal/cm ² Single lens Arc Shield w/riveted Velcro®	Polycarbonate, Velcro®, Plastic Alloy		NFPA 70E, ANSI Z87.1+, ASTM F2178, EN 166, GS-ET-29*2	25*5	2*7
IM22-AFA-40-V-HTS	2190754	Premium* coated 40 cal/cm ² Single lens Arc Shield w/riveted Velcro®	Polycarbonate, Velcro®, Plastic Alloy		NFPA 70E, ANSI Z87.1+, ASTM F2178, EN 166, GS-ET-29*2	40*5	2*7

DUAL LENS MODELS

Product Code	Part No.	Description	Material	Color	Standard	ATPV*4	APC*6
IM22-AFA2-40-V-HT	2190755	Premium* coated 40 cal/cm ² Dual lens Arc Shield w/riveted Velcro®	Polycarbonate, Velcro®, Plastic Alloy		NFPA 70E, ANSI Z87.1+, ASTM F2178, EN 166, GS-ET-29*2	40*5	2*7
IM22-AFA2-75-V-HT	2190751	Premium* coated 75 cal/cm ² Dual lens Arc Shield w/riveted Velcro®	Polycarbonate, Velcro®, Plastic Alloy		NFPA 70E, ANSI Z87.1+, ASTM F2178, EN 166, GS-ET-29*2	75*5	2*7
IM22-AFA2-100-V-HT	2190757	Premium* coated 100 cal/cm ² Dual lens Arc Shield w/riveted Velcro®	Polycarbonate, Velcro®, Plastic Alloy		NFPA 70E, ANSI Z87.1+, ASTM F2178, EN 166, GS-ET-29*2	100*5	2*7

HELMET BRACKETS

Product Code	Part No.	Description	Material	Color	Standard	ATPV*4	APC*6
CB2-HD	9004860	High Temp Bracket for slotted caps w/NEW Press-to-Release US clips	Nylon		NFPA 70E, ANSI Z87.1+, ASTM F2178, EN 166, GS-ET-29*3	n/a	2*7
CB2-HD-CT	9004870	High Temp Bracket for slotted caps w/EURO clips	Nylon		NFPA 70E, ANSI Z87.1+, ASTM F2178, EN 166, GS-ET-29*3	n/a	2*7
CB6-HD	9005212	High Temp Bracket for slotted / un-slotted caps w/elastomeric band	Nylon		NFPA 70E, ANSI Z87.1+, ASTM F2178, EN 166, GS-ET-29*3	n/a	2*7

REPLACEMENT CLIPS

Product Code	Part No.	Description	Material	Color	Standard	ATPV* ⁴	APC* ⁶
CBA-CT	9004869	EURO clips* ⁸	Nylon	●	NFPA 70E, ANSI Z87.1+, ASTM F2178, EN 166, GS-ET-29* ³	n/a	2* ⁷
A-TPH	1603900	Replacement kit of screws, washers and knobs	Nylon	●	NFPA 70E, ANSI Z87.1+, ASTM F2178, EN 166, GS-ET-29* ³	n/a	2* ⁷

ARCVENT™

Product Code	Part No.	Description	Material	Color	Standard	ATPV* ⁴	APC* ⁶
AV-O	9080000	Octagonal ArcVent™	Flame-Retardant Elastomer	●	NFPA 70E, ASTM F2178, EN 166, GS-ET-29* ²	100* ⁵	2* ⁷
AV-H	9080002	Hexagonal ArcVent™	Flame-Retardant Elastomer	●	NFPA 70E, ASTM F2178, EN 166, GS-ET-29* ²	100* ⁵	2* ⁷
AV-R	9080001	Rectangular ArcVent™	Flame-Retardant Elastomer	●	NFPA 70E, ASTM F2178, EN 166, GS-ET-29* ²	100* ⁵	2* ⁷

* Anti-abrasion Hard Coating (outside) plus permanent Anti-fog Coating (inside)

*² designed to meet specific standards, when combined w/Arc Flash Hood

*³ designed to meet specific standards, when combined w/Arc Shield

*⁴ Arc Thermal Performance Value as per ASTM F2178, measured in cal/cm²

*⁵ possible ATPV, when combined w/Arc Flash Hood

*⁶ Arc Protection Class (APC) as per GS-ET-29

*⁷ designed to meet APC 2, when combined w/Arc Flash Hood

*⁸ custom clips on special request



ARC GOGGLES AND BALACLAVAS

Arc Goggles and Balaclavas are designed to be used in confined spaces and feature less weight and bulk as compared to a Hood. The new Highly Transparent HT™ Arc Goggles feature an optically corrected single lens system and a Premium coating, consisting of an Anti-abrasion Hard Coating plus permanent Anti-fog Coating. They meet the performance specifications of NFPA 70E, ANSI Z87.1+ and GS-ET-29 (Arc Protection Class 2) and are tested under ASTM F2178 up to 50 cal/cm². NOTE: Arc Goggles do not meet the face shield requirements of NFPA 70E.

Color / ATPV

18 38 50

Coating

PREMIUM

Silicone Frame and Strap

Adjustable Pivots

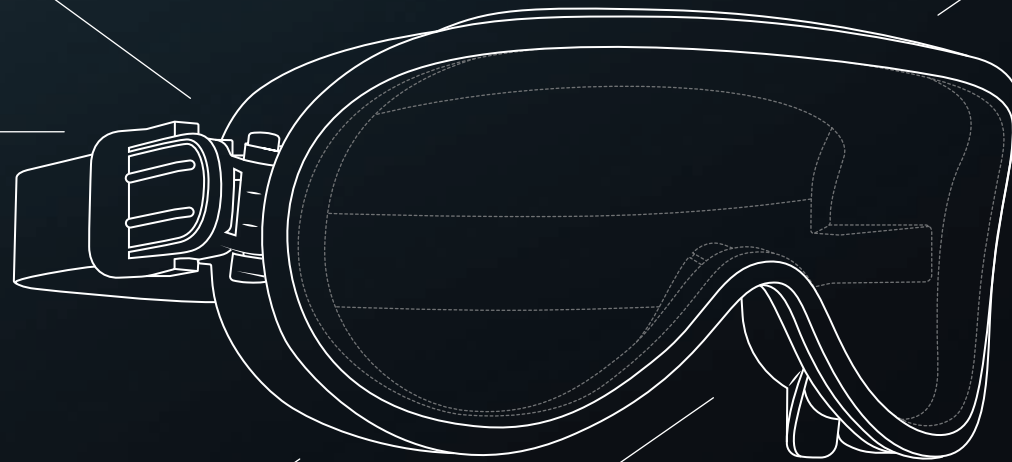

Optically Corrected Single Lens

Nose Protection





Balaclavas

LOW ENERGY MEDIUM ENERGY HIGH ENERGY

ANSI Z87.1 NFPA 70E ASTM F2178 EN 166 GS-ET-29

ARC GOGGLES

Product Code	Part No.	Description	Material	Color	Standard	ATPV* ⁵	APC* ⁶	
510-ARC-SN 18-HT	2140072	Premium* coated Low Energy Arc Flash Goggle w/nose shield	Silicone, Polycarbonate, Plastic alloy		ANSI Z87.1+, ASTM F2178* ² , GS-ET-29* ²	18	2* ⁷	NEW
510-ARC 38-HT	2140071	Premium* coated Medium Energy Arc Flash Goggle	Silicone, Polycarbonate, Plastic alloy		ANSI Z87.1+, ASTM F2178* ² , GS-ET-29* ²	38	2* ⁷	NEW
510-ARC-S 50-HT	2140073	Premium* coated High Energy Arc Flash Goggle	Silicone, Polycarbonate, Plastic alloy		ANSI Z87.1+, ASTM F2178* ² , GS-ET-29* ²	50	2* ⁷	NEW

ARC BALACLAVAS

Product Code	Part No.	Description	Material	Color	Standard	ATPV* ⁵	APC* ⁶
ARC-BALA-LE	2130131	Low Energy Arc Flash Balaclava	Carbon, Kevlar		OSHA 29 CFR 1910.269, ASTM 1506, ASTM F2178, NFPA 70E	12	Ø
ARC-BALA-ME	2130078	Medium Energy Arc Flash Balaclava	Carbon, Kevlar		OSHA 29 CFR 1910.269, ASTM 1506, ASTM F2178, NFPA 70E	40	Ø
ARC-BALA-HE	2130077	High Energy Arc Flash Balaclava	Carbon X		OSHA 29 CFR 1910.269, ASTM 1506, ASTM F2178, NFPA 70E, GS-ET-29* ³ , IEC 61482-2* ⁴ , IEC 61482-1-2* ⁴ , ISO 11612* ⁴	50	2* ⁸

* Anti-abrasion Hard Coating (outside) plus permanent Anti-fog Coating (inside)

*² in combination w/Arc Balaclava

*³ in combination w/Arc Goggle

*⁴ designed to meet specific FR Garment standards

*⁵ Arc Thermal Performance Value as per ASTM F2178, measured in cal/cm²

*⁶ Arc Protection Class (APC) as per GS-ET-29

*⁷ designed to meet APC 2, when combined w/High Energy Arc Balaclava

*⁸ designed to meet APC 2, when combined w/Arc Goggle





ECO ARC SHIELD

The Eco Arc Shield is the low-cost alternative to the AmpShield® series. Equipped with an HT™ Nanoparticle window, it provides an anti-fog coated inner lens and a non-transparent Ergonomic chin protector. The Eco Arc Shield also features helmet brackets with the unique LeverLock® mounting system to allow for quick visor replacement. As the Eco Arc Shield is shipped unassembled to the customer, transportation costs are reduced significantly.

Helmet Clips

US OEM

LeverLock® Mounting System

Helmet Brackets



Color / ATPV

10 18





Permanent Anti-Fog
Coated Inner Lens

Ergonomic Chin Protector

ANSI Z87.1 NFPA 70E ASTM F2178



ECO ARC SHIELD KITS

Product Code	Part No.	Description	Material	Color	Standard	ATPV*	APC**	
ECOARC1-10HT	9104881	Economy Arc Shield w/HT™ nanoparticle lens, anti-fog coated inner lens, Ergonomic Chin protector and cap bracket (w/NEW Press-to-Release US clips), 10 cal/cm ²	Polycarbonate, Nylon		ANSI Z87.1+, ASTM 2178, NFPA 70E	10	Ø	NEW
ECOARC2-10HT	9104884	Economy Arc Shield w/HT™ nanoparticle lens, anti-fog coated inner lens, Ergonomic Chin protector and cap bracket (elastomeric band), 10 cal/cm ²	Polycarbonate, Nylon		ANSI Z87.1+, ASTM 2178, NFPA 70E	10	Ø	NEW
ECOARC1-18HT	9204881	Economy Arc Shield w/HT™ nanoparticle lens, anti-fog coated inner lens, Ergonomic Chin protector and cap bracket (w/NEW Press-to-Release US clips), 18 cal/cm ²	Polycarbonate, Nylon		ANSI Z87.1+, ASTM 2178, NFPA 70E	18	Ø	NEW
ECOARC2-18HT	9104883	Economy Arc Shield w/HT™ nanoparticle lens, anti-fog coated inner lens, Ergonomic Chin protector and cap bracket (elastomeric band), 18 cal/cm ²	Polycarbonate, Nylon		ANSI Z87.1+, ASTM 2178, NFPA 70E	18	Ø	NEW

* Arc Thermal Performance Value as per ASTM F2178, measured in cal/cm²

** Arc Protection Class (APC) as per GS-ET-29





EUROPEAN CLASS 1 ARC SHIELDS

The European Class 1 Arc Shields meet the performance specifications of EN 166 and GS-ET-29 (Arc Protection Class 1). They are designed for use with slotted/unslotted helmets and headgear. Specific models are available with chin protectors for additional protection and comfort.

Helmet Brackets



Helmet Clips



Color / ATPV



Headgear



Headgear w/Chin Protector

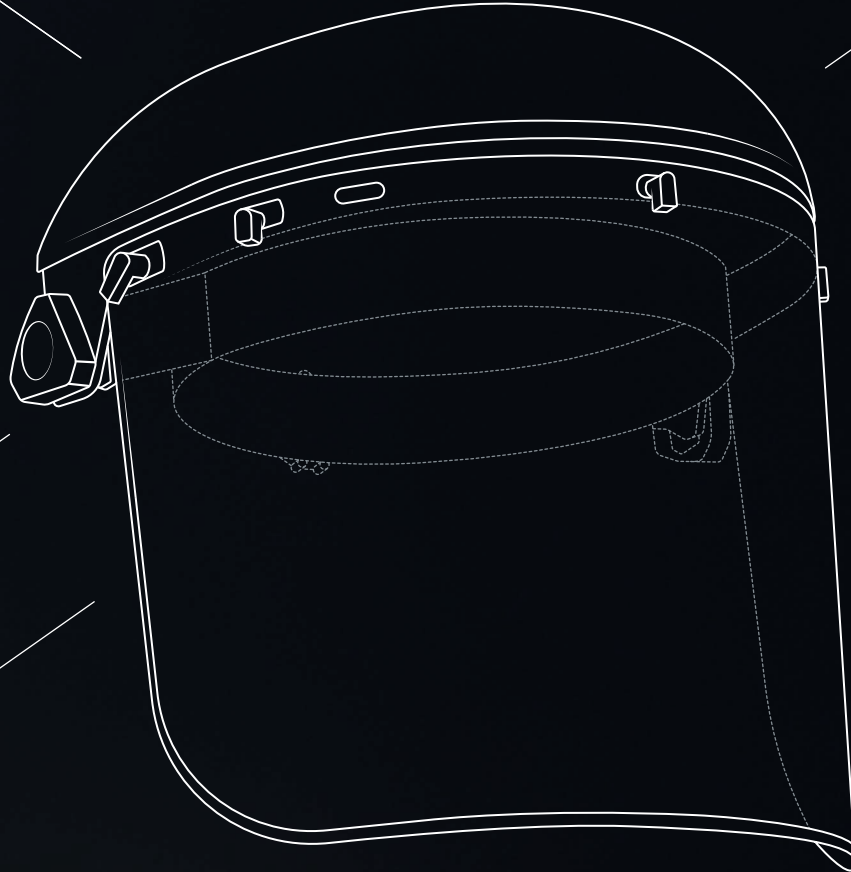

KITS WIHELMET BRACKET

Product Code	Part No.	Description	Material	Color	Standard	ATPV*4	APC*5
ARC-E 1 SK1-PCT	2189000	Class 1 Arc Shield kit w/Cap Bracket (EURO clips)	Polycarbonate, Nylon	○	EN 166, ANSI Z87.1+, GS-ET-29	∅	1
ARC-E 1 SK2	2189001	Class 1 Arc Shield kit w/Cap Bracket (elastomeric band)	Polycarbonate, Nylon	○	EN 166, ANSI Z87.1+, GS-ET-29	∅	1

KITS WIHEADGEAR

Product Code	Part No.	Description	Material	Color	Standard	ATPV*4	APC*5
ARC-E 1 SK4	2189002	Class 1 Arc Shield kit w/Headgear	Polycarbonate, Nylon	○	EN 166, ANSI Z87.1+, GS-ET-29	∅	1
ARC-E 1 SK7	2189003	Class 1 Arc Shield kit w/large Headgear	Polycarbonate, Nylon	○	EN 166, ANSI Z87.1+, GS-ET-29	∅	1







KITS WIHEADGEAR AND CHIN PROTECTOR

Product Code	Part No.	Description	Material	Color	Standard	ATPV*4	APC*5
ARC-E 1 S2K5C	2189004	Class 1 Arc Shield kit w/clear Headgear and clear chin protector	Polycarbonate, Nylon	○	EN 166, ANSI Z87.1+, GS-ET-29*	∅	1*6
ARC-E 1 S2K5H	2189005	Class 1 Arc Shield kit w/black Headgear and black chin protector	Polycarbonate, Nylon	●	EN 166, ANSI Z87.1+, GS-ET-29*	∅	1*6

REPLACEMENT SHIELDS

Product Code	Part No.	Description	Material	Color	Standard	ATPV*4	APC*5
ARC-E1-RW	2189006	Class 1 Replacement Arc Shield	Polycarbonate, Nylon	○	EN 166, ANSI Z87.1+, GS-ET-29*7	∅	1*7
ARC-E1-RW-CP	2189007	Class 1 Replacement Arc Shield w/chin protector hole pattern	Polycarbonate, Nylon	○	EN 166, ANSI Z87.1+, GS-ET-29*7	∅	1*7

HELMET BRACKETS AND HEADGEAR

Product Code	Part No.	Description	Material	Color	Standard	ATPV*5	APC*8
CB2-HD-CT	9004870	High Temp Bracket for slotted caps w/EURO clips	Nylon		NFPA 70E, ANSI Z87.1+, ASTM F2178, EN 166, GS-ET-29*2	n/a	2*8
CB6-HD	9005212	High Temp Bracket for slotted/un-slotted caps w/elastomeric band	Nylon		NFPA 70E, ANSI Z87.1+, ASTM F2178, EN 166, GS-ET-29*2	n/a	2*8
HG4-H	2001600	High Temp Ratchet Headgear w/large spark guard	Nylon		EN 166, ANSI Z87.1+, GS-ET-29*2	n/a	2*9
HG7-H	2002200	High Temp Ratchet Headgear w/extra large spark guard	Nylon		EN 166, ANSI Z87.1+, GS-ET-29*2	n/a	2*9
HG5-C	2001810	High Temp Ratchet Headgear w/large spark guard and chin protector	Polycarbonate, Nylon		EN 166, ANSI Z87.1+, GS-ET-29*3	n/a	2*9
HG5-H	2001800	High Temp Ratchet Headgear w/large spark guard and chin protector	Polycarbonate, Nylon		EN 166, ANSI Z87.1+, GS-ET-29*3	n/a	2*9

REPLACEMENT CLIPS

Product Code	Part No.	Description	Material	Color	Standard	ATPV*4	APC*5
CBA-CT	9004869	EURO Clips*10	Nylon		NFPA 70E, ANSI Z87.1+, ASTM F2178, EN 166, GS-ET-29*2	n/a	2*8
A-TPH	1603900	Replacement kit of screws, washers and knobs	Nylon		NFPA 70E, ANSI Z87.1+, ASTM F2178, EN 166, GS-ET-29*2	n/a	2*8

* designed to meet GS-ET-29

*2 designed to meet specific standards, when combined w/Arc Shield

*3 designed to meet GS-ET-29, when combined w/Arc Shield

*4 Arc Thermal Performance Value as per ASTM F2178, measured in cal/cm²

*5 Arc Protection Class (APC) as per GS-ET-29

*6 designed to meet APC 1

*7 designed to meet GS-ET-29 APC 1, when combined w/Arc Flash helmet bracket or headgear

*8 designed to meet APC 2, when combined w/Arc Shield

*9 designed to meet APC 1, when combined w/Arc Shield

*10 custom clips on special request

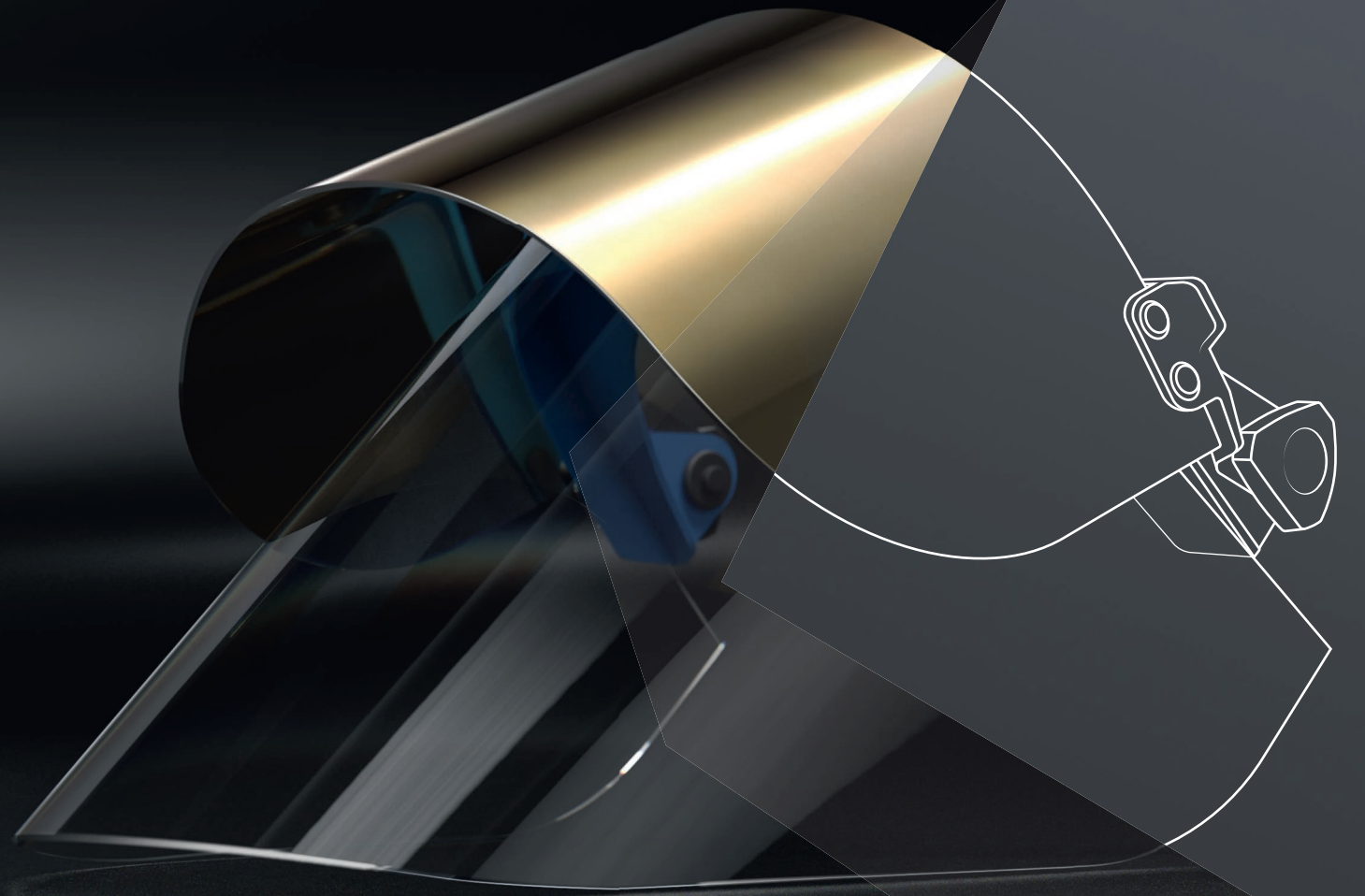

INDUSTRIAL PPE

The PAULSON Industrial PPE consists of multiple categories including Metalized Face Shields, High Temperature Face Shields, High Performance Face Shields, Shaded Face Shields, Specialty Face Shields, QuickView™ Shields, Specialty Goggles, Sun Shields and Knee Shields. Designed to meet the many different safety needs for industry worldwide. Our Industrial products are made from high quality materials and modern manufacturing processes.

They provide superior optical properties and are lightweight and robust. In operation they are comfortable to wear, and easy to use. PAULSON offers various products to provide eye and face protection against hazards like chemical splash, extreme heat, radiation and impacts.

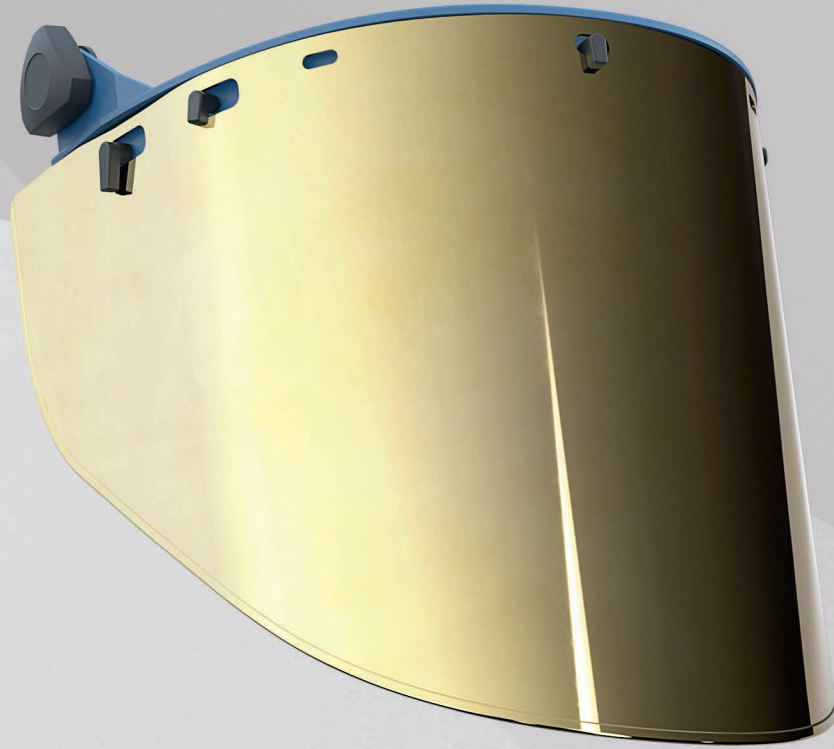







METALIZED FACE SHIELDS

Our injection molded Nanoparticle Gold Shields are designed to be used by mill and foundry workers. They are manufactured from Polycarbonate and coated with 99,99% Fine Gold, while the Gold coating itself is protected by a hard coating for extended service life. The Gold Shields are designed to block the extreme radiant heat from molten metal and to optimize the Visible Light Transmittance (VLT) to allow the best possible view while working.

The Aluminized Face Shields are made from flat, die-cut Polycarbonate sheet material and are laminated with aluminized film. They are a low cost alternative for our customers in high heat applications, where molten metal with lower temperature, like Aluminum, is processed.







GOLD SHIELDS

Product Code	Part No.	Description	Material	Size	Color	Weight	Standard
IM13-GHC8FM	2111203	Gold hard coated Face Shield w/medium green tinting and chin protector hole pattern	Polycarbonate	15,2 × 39,4 × 0,2 cm		227 g	ANSI Z87.1+
IM20-GHC6F	2119880	Gold hard coated Face Shield, Headgear compatibility	Polycarbonate	25,4 × 50,8 × 0,15 cm		227 g	ANSI Z87.1+
IM20-GHC6FM	2119890	Gold hard coated Face Shield w/medium green tinting, Headgear compatibility	Polycarbonate	25,4 × 50,8 × 0,15 cm		227 g	ANSI Z87.1+
IM22-GHC6F	2119882	Gold hard coated Face Shield, Bracket compatibility	Polycarbonate	25,4 × 50,8 × 0,15 cm		227 g	ANSI Z87.1+
IM22-GHC6FM	2119884	Gold hard coated Face Shield w/medium green tinting, Bracket compatibility	Polycarbonate	25,4 × 50,8 × 0,15 cm		227 g	ANSI Z87.1+
IM20-XGHC6FD	2119895	Extra Gold hard coated Face Shield w/dark green tinting, Headgear compatibility	Polycarbonate	25,4 × 50,8 × 0,15 cm		227 g	ANSI Z87.1+
IM22-XGHC6FD	2119903	Extra Gold hard coated Face Shield w/dark green tinting, Bracket compatibility	Polycarbonate	25,4 × 50,8 × 0,15 cm		227 g	ANSI Z87.1+



GOLD SHIELDS FOR HOODS

Product Code	Part No.	Description	Material	Size	Color	Weight	Standard
IM14-GHC12F	2111810	Gold hard coated Face Shield for Aluminized Hoods	Polycarbonate	17,8 × 27,9 × 0,32 cm		397 g	ANSI Z87.1+









EU GOLD SHIELDS AND KITS

Product Code	Part No.	Description	Material	Size	Color	Weight	Standard	
IM22-GHC6F-EU	2198000	Clear Gold hard coated Face Shield	Polycarbonate	25,4 × 50,8 × 0.15 cm		227 g	ANSI Z87.1+, EN 166	NEW
IM22-GHC6F3-EU	2198100	Shade 3 Gold hard coated Face Shield	Polycarbonate	25,4 × 50,8 × 0.15 cm		227 g	ANSI Z87.1+, EN 166*	NEW
IM22-GHC6F5-EU	2198001	Shade 5 Gold hard coated Face Shield	Polycarbonate	25,4 × 50,8 × 0.15 cm		227 g	ANSI Z87.1+, EN 166*	NEW
GHR51	2200000	Clear Gold hard coated Face Shield kit w/Bracket for slotted caps, NEW Press-to-Release US clips	Polycarbonate, Nylon	25,4 × 50,8 × 0,15 cm		312 g	ANSI Z87.1+, EN 166	NEW
GHR51-CT	2210000	Clear Gold hard coated Face Shield kit w/Bracket for slotted caps, EURO clips	Polycarbonate, Nylon	25,4 × 50,8 × 0,15 cm		312 g	ANSI Z87.1+, EN 166	NEW
GHR52	2220000	Clear Gold hard coated Face Shield kit w/Bracket for slotted and un-slotted caps, elastomeric band	Polycarbonate, Nylon	25,4 × 50,8 × 0,15 cm		326 g	ANSI Z87.1+, EN 166	NEW







ALUMINIZED SHIELDS

Product Code	Part No.	Description	Material	Size	Color	Weight	Standard	
S72-L4HR	9002900	Aluminized heat reflective Face Shield, Headgear compatibility	Polycarbonate	25,4 × 50,8 × 0,10 cm		136 g	ANSI Z87.1+, EN 166*	NEW
S73-L4HR	9002901	Aluminized heat reflective Face Shield, Bracket compatibility	Polycarbonate	25,4 × 50,8 × 0,10 cm		136 g	ANSI Z87.1+, EN 166*	NEW

BRACKETS

Product Code	Part No.	Description	Material	Size	Color	Weight	Standard
CB2-HD	9004860	High Temp Bracket for slotted caps w/NEW Press-to-Release US clips	Nylon	n/a		85 g	ANSI Z87.1+, EN 166
CB2-HD-CT	9004870	High Temp Bracket for slotted caps w/EURO clips	Nylon	n/a		85 g	ANSI Z87.1+, EN 166
CB6-HD	9005212	High Temp Bracket for slotted/un-slotted caps w/elastomeric band	Nylon	n/a		99 g	ANSI Z87.1+, EN 166
CB5-HD	9005050	Large High Temp Bracket for slotted caps w/NEW Press-to-Release US clips	Nylon	n/a		100 g	ANSI Z87.1+, EN 166*
HB2-HD	9102401	High Temp Bracket for slotted/un-slotted hats w/elastomeric band	Nylon	n/a		99 g	ANSI Z87.1+, EN 166*
CB10-PA	9005010	Aluminum front mounting cap bracket w/spring retainer	Aluminium	n/a		113 g	ANSI Z87.1+
CB11-CA	9005020	Aluminum rear mounting cap bracket w/spring retainer	Aluminium	n/a		113 g	ANSI Z87.1+
CB12-HA	9005030	Aluminum front mounting hat bracket w/spring retainer	Aluminium	n/a		113 g	ANSI Z87.1+

WEIGHT COMPENSATING BRACKETS

Product Code	Part No.	Description	Material	Size	Color	Weight	Standard	
WCB-CS	9042022	Slotted Cap Bracket, Weight-Compensating	Nylon	n/a		82g	ANSI Z87.1+, EN 166*	NEW
WCB-CSP	9042030	Slotted Bracket, Weight-Compensating, Petzl® Safty Helmet Compatible	Nylon	n/a		82g	ANSI Z87.1+, EN 166*	NEW
WCB-CSK	9042040	Slotted Bracket, Weight-Compensating, KASK® Safty Helmet Compatible	Nylon	n/a		82g	ANSI Z87.1+, EN 166*	NEW
WCB-CSB	9042050	Slotted Bracket, Weight-Compensating, Bullard® Safty Helmet Compatible	Nylon	n/a		82g	ANSI Z87.1+, EN 166*	NEW
WCB-CS3M	9042070	Slotted Bracket, Weight-Compensating, 3M® Safty Helmet Compatible	Nylon	n/a		82g	ANSI Z87.1+, EN 166*	NEW
WCB-CSM	9042080	Slotted Bracket, Weight-Compensating, MSA® Safty Helmet Compatible	Nylon	n/a		82g	ANSI Z87.1+, EN 166*	NEW

HEADGEAR

Product Code	Part No.	Description	Material	Size	Color	Weight	Standard
HG4-H	2001600	High Temp Ratchet Headgear w/large spark guard	Nylon	n/a	●	85 g	ANSI Z87.1+, EN 166
HG7-H	2002200	High Temp Ratchet Headgear w/extra large spark guard	Nylon	n/a	●	113 g	ANSI Z87.1+, EN 166
HG5-C	2001810	High Temp Ratchet Headgear w/large spark guard and chin protector	Polycarbonate	n/a	○	113 g	ANSI Z87.1+, EN 166
HG5-H	2001800	High Temp Ratchet Headgear w/large spark guard and chin protector	Nylon	n/a	●	113 g	ANSI Z87.1+, EN 166

ACCESSORIES

Product Code	Part No.	Description	Material	Size	Color	Weight	Standard
A-CP/B	1602000	Black chin protector	Nylon	n/a	●	28 g	ANSI Z87.1+, EN 166
A-CP/C	1602100	Clear chin protector	Polycarbonate	n/a	○	28 g	ANSI Z87.1+, EN 166
A-TPH	1603900	Replacement kit of screws, washers and knobs	Nylon	n/a	●	10 g	ANSI Z87.1+, EN 166
CBA-CT	9004869	EURO clips* ²	Nylon	n/a	●	15 g	ANSI Z87.1+, EN 166

* designed to meet EN 166

*² custom clips on special request





HIGH TEMPERATURE FACE SHIELDS

The High Temperature Face Shields are designed and sized for the most demanding industrial applications. These Face Shields should be matched with other components that are rated for high temperature use. All High Temperature Face Shields are injection molded, optically corrected and made of Polycarbonate.

FACE SHIELDS

Product Code	Part No.	Description	Material	Size	Color	Weight	Standard
IM9-L6F	2107600	Injection molded Face Shield	Polycarbonate	20,3 × 39,4 × 0,15 cm	○	227 g	ANSI Z87.1+, EN 166*
IM9-L6FD	2108000	Injection molded Face Shield w/dark green tinting	Polycarbonate	20,3 × 39,4 × 0,15 cm	●	227 g	ANSI Z87.1+, EN 166*
IM10-L8F	2108200	Injection molded Face Shield w/2mm thickness	Polycarbonate	20,3 × 39,4 × 0,2 cm	○	397 g	ANSI Z87.1+, EN 166*
IM10-L8FM	2108400	Injection molded Face Shield w/2mm thickness and medium green tinting	Polycarbonate	20,3 × 39,4 × 0,2 cm	●	397 g	ANSI Z87.1+, EN 166*
IM10-L8FD	2108600	Injection molded Face Shield w/2mm thickness and dark green tinting	Polycarbonate	20,3 × 39,4 × 0,2 cm	●	397 g	ANSI Z87.1+, EN 166*
IM10-L8FCP	2108203	Injection molded Face Shield w/chin protector hole pattern	Polycarbonate	20,3 × 39,4 × 0,2 cm	○	397 g	ANSI Z87.1+, EN 166*
IM12-L6F	2110601	Injection molded face shield/ comp. w/HG5-H, HG5-C	Polycarbonate	15,2 × 39,4 × 0,15 cm	○	227g	ANSI Z87.1, EN 166*
IM20-L6F	2119800	Large injection molded Face Shield, Headgear compatibility	Polycarbonate	25,4 × 50,8 × 0,15 cm	○	255 g	ANSI Z87.1+, EN 166*
IM20-L6FM	2120000	Large injection molded Face Shield w/medium green tinting, Headgear compatibility	Polycarbonate	25,4 × 50,8 × 0,15 cm	●	255 g	ANSI Z87.1+, EN 166*
IM20-L6FD	2120200	Large injection molded Face Shield w/dark green tinting, Headgear compatibility	Polycarbonate	25,4 × 50,8 × 0,15 cm	●	255 g	ANSI Z87.1+, EN 166*
IM20-N6F	2191000	Large injection molded Nylon Face Shield, Headgear compatibility	Nylon	25,4 × 50,8 × 0,15 cm	○	158 g	ANSI Z87.1+, EN 166*
IM21-L6F	2119810	Large injection molded Face Shield, Fibre-Metal® Bracket compatibility	Polycarbonate	25,4 × 50,8 × 0,15 cm	○	255 g	ANSI.Z87.1+
IM21-L6FD	2119980	Large injection molded Face Shield w/dark green tinting, Fibre-Metal® Bracket compatibility	Polycarbonate	25,4 × 50,8 × 0,15 cm	●	255 g	ANSI.Z87.1+
IM22-L6F	2119840	Large injection molded Face Shield, Bracket compatibility	Polycarbonate	25,4 × 50,8 × 0,15 cm	○	255 g	ANSI Z87.1+, EN 166*
IM22-L6FM	2120010	Large injection molded Face Shield w/medium green tinting, Bracket compatibility	Polycarbonate	25,4 × 50,8 × 0,15 cm	●	255 g	ANSI Z87.1+, EN 166*
IM22-L6FD	2119970	Large injection molded Face Shield w/dark green tinting, Bracket compatibility	Polycarbonate	25,4 × 50,8 × 0,15 cm	●	255 g	ANSI Z87.1+, EN 166*
IM23-N6F	2140040	Large injection molded face shield/ w/chin protector, Bracket and Headgear compatibility	Nylon	25,4 × 50,8 × 0,15 cm	○●	249 g	ANSI Z87.1+, EN 166*
S26-L6F	2300900	Die cut Face Shield, thermoformed	Polycarbonate	23,5 × 39,7 × 0,15 cm	○	51 g	ANSI Z87.1+, EN 166*
S71-L6F	9002800	Large die cut Face Shield, thermoformed	Polycarbonate	25,4 × 61 × 0,15 cm	○	51 g	ANSI Z87.1+, EN 166*









NEW

NEW





FACE SHIELDS FOR HOODS

Product Code	Part No.	Description	Material	Size	Color	Weight	Standard
IM14-L12F	2111800	Injection Molded Face Shield for High Temp Hoods	Polycarbonate	17,8 × 27,9 × 0,32 cm		397 g	ANSI Z87.1+





BRACKETS

Product Code	Part No.	Description	Material	Size	Color	Weight	Standard
CB2-HD	9004860	High Temp Bracket for slotted caps w/NEW Press-to-Release US clips	Nylon	n/a		85 g	ANSI Z87.1+, EN 166
CB2-HD-CT	9004870	High Temp Bracket for slotted caps w/EURO clips	Nylon	n/a		85 g	ANSI Z87.1+, EN 166
CB6-HD	9005212	High Temp Bracket for slotted / un-slotted caps w/elastomeric band	Nylon	n/a		99 g	ANSI Z87.1+, EN 166
CB5-HD	9005050	Large High Temp Bracket for slotted caps w/NEW Press-to-Release US clips	Nylon	n/a		100 g	ANSI Z87.1+, EN 166*
HB2-HD	9102401	High Temp Bracket for slotted / un-slotted hats w/elastomeric band	Nylon	n/a		99 g	ANSI Z87.1+, EN 166*
CB10-PA	9005010	Aluminum front mounting cap bracket w/spring retainer	Aluminium	n/a		113 g	ANSI Z87.1+
CB11-CA	9005020	Aluminum rear mounting cap bracket w/spring retainer	Aluminium	n/a		113 g	ANSI Z87.1+
CB12-HA	9005030	Aluminum front mounting hat bracket w/spring retainer	Aluminium	n/a		113 g	ANSI Z87.1+

WEIGHT COMPENSATING BRACKETS

Product Code	Part No.	Description	Material	Size	Color	Weight	Standard	
WCB-CS	9042022	Slotted Cap Bracket, Weight-Compensating	Nylon	n/a		82g	ANSI Z87.1+	NEW
WCB-CSP	9042030	Slotted Bracket, Weight-Compensating, Petzl® Safty Helmet Compatible	Nylon	n/a		82g	ANSI Z87.1+	NEW
WCB-CSK	9042040	Slotted Bracket, Weight-Compensating, KASK® Safty Helmet Compatible	Nylon	n/a		82g	ANSI Z87.1+	NEW
WCB-CSB	9042050	Slotted Bracket, Weight-Compensating, Bullard® Safty Helmet Compatible	Nylon	n/a		82g	ANSI Z87.1+	NEW
WCB-CS3M	9042070	Slotted Bracket, Weight-Compensating, 3M® Safty Helmet Compatible	Nylon	n/a		82g	ANSI Z87.1+	NEW
WCB-CSM	9042080	Slotted Bracket, Weight-Compensating, MSA® Safty Helmet Compatible	Nylon	n/a		82g	ANSI Z87.1+	NEW

HEADGEAR

Product Code	Part No.	Description	Material	Size	Color	Weight	Standard
HG4-H	2001600	High Temp Ratchet Headgear w/large spark guard	Nylon	n/a		85g	ANSI Z87.1+, EN 166
HG7-H	2002200	High Temp Ratchet Headgear w/extra large spark guard	Nylon	n/a		113g	ANSI Z87.1+, EN 166
HG5-C	2001810	High Temp Ratchet Headgear w/large spark guard and chin protector	Polycarbonate	n/a		113g	ANSI Z87.1+, EN 166
HG5-H	2001800	High Temp Ratchet Headgear w/large spark guard and chin protector	Nylon	n/a		113g	ANSI Z87.1+, EN 166

ACCESSORIES

Product Code	Part No.	Description	Material	Size	Color	Weight	Standard
A-CP/B	1602000	Black chin protector	Nylon	n/a	●	28 g	ANSI Z87.1+, EN 166
A-CP/C	1602100	Clear chin protector	Polycarbonate	n/a	○	28 g	ANSI Z87.1+, EN 166
A-TPH	1603900	Replacement kit of screws, washers and knobs	Nylon	n/a	●	10 g	ANSI Z87.1+, EN 166
CBA-CT	9004869	EURO clips* ²	Nylon	n/a	●	15 g	ANSI Z87.1+, EN 166

* designed to meet EN 166

*² custom clips on special request









HIGH PERFORMANCE FACE SHIELDS

The High Performance Face Shields are designed to provide an engineered advantage in performance and value. All High Performance Face Shields are injection molded and optically corrected. The Tritan™ material used in these Face Shields blends toughness with chemical resistance.







FACE SHIELDS

Product Code	Part No.	Description	Material	Size	Color	Weight	Standard
IM9-P6F	2107000	Injection molded Face Shield	Tritan™	20,3 × 39,4 × 0,15 cm	○	227 g	ANSI Z87.1+, EN 166*
IM9-P6FD	2107400	Injection molded Face Shield w/dark green tinting	Tritan™	20,3 × 39,4 × 0,15 cm	●	227 g	ANSI Z87.1+
IM12-P6F	2110505	Injection molded Face Shield w/chin protector hole pattern	Tritan™	15,2 × 39,4 × 0,15 cm	○	227 g	ANSI Z87.1+, EN 166*
IM20-P6F	2119200	Large injection molded Face Shield, Headgear compatibility	Tritan™	25,4 × 50,8 × 0,15 cm	○	255 g	ANSI Z87.1+, EN 166*
IM20-P6FD	2119600	Large injection molded Face Shield w/dark green tinting, Headgear compatibility	Tritan™	25,4 × 50,8 × 0,15 cm	●	255 g	ANSI Z87.1+
IM21-P6F	2119602	Large injection molded Face Shield, Fibre-Metal® Bracket compatibility	Tritan™	25,4 × 50,8 × 0,15 cm	○	255 g	ANSI Z87.1+
IM21-P6FD	2119241	Large injection molded Face Shield w/dark green tinting, Fibre-Metal® Bracket compatibility	Tritan™	25,4 × 50,8 × 0,15 cm	●	255 g	ANSI Z87.1+
IM22-P6F	2119230	Large injection molded Face Shield, Bracket compatibility	Tritan™	25,4 × 50,8 × 0,15 cm	○	255 g	ANSI Z87.1+, EN 166*

BRACKETS

Product Code	Part No.	Description	Material	Size	Color	Weight	Standard
CB2-HD	9004860	High Temp Bracket for slotted caps w/NEW Press-to-Release US clips	Nylon	n/a		85 g	ANSI Z87.1+, EN 166
CB2-HD-CT	9004870	High Temp Bracket for slotted caps w/EURO clips	Nylon	n/a		85 g	ANSI Z87.1+, EN 166
CB6-HD	9005212	High Temp Bracket for slotted / un-slotted caps w/elastomeric band	Nylon	n/a		99 g	ANSI Z87.1+, EN 166
CB5-HD	9005050	Large High Temp Bracket for slotted caps w/NEW Press-to-Release US clips	Nylon	n/a		100 g	ANSI Z87.1+, EN 166*
HB2-HD	9102401	High Temp Bracket for slotted / un-slotted hats w/elastomeric band	Nylon	n/a		99 g	ANSI Z87.1+, EN 166*

WEIGHT COMPENSATING BRACKETS

Product Code	Part No.	Description	Material	Size	Color	Weight	Standard	
WCB-CS	9042022	Slotted Cap Bracket, Weight-Compensating	Nylon	n/a		82g	ANSI Z87.1+, EN 166*	NEW
WCB-CSP	9042030	Slotted Bracket, Weight-Compensating, Petzl® Safty Helmet Compatible	Nylon	n/a		82g	ANSI Z87.1+, EN 166*	NEW
WCB-CSK	9042040	Slotted Bracket, Weight-Compensating, KASK® Safty Helmet Compatible	Nylon	n/a		82g	ANSI Z87.1+, EN 166*	NEW
WCB-CSB	9042050	Slotted Bracket, Weight-Compensating, Bullard® Safty Helmet Compatible	Nylon	n/a		82g	ANSI Z87.1+, EN 166*	NEW
WCB-CS3M	9042070	Slotted Bracket, Weight-Compensating, 3M® Safty Helmet Compatible	Nylon	n/a		82g	ANSI Z87.1+, EN 166*	NEW
WCB-CSM	9042080	Slotted Bracket, Weight-Compensating, MSA® Safty Helmet Compatible	Nylon	n/a		82g	ANSI Z87.1+, EN 166*	NEW

HEADGEAR

Product Code	Part No.	Description	Material	Size	Color	Weight	Standard
HG1-S	2000100	Pinlock headgear w/small spark guard	HDPE	n/a	●	86 g	ANSI Z87.1+, EN 166*
HG4-S	2001200	Ratchet headgear w/large spark guard	HDPE	n/a	●	86 g	ANSI Z87.1+, EN 166*
HG4-H	2001600	High Temp Ratchet Headgear w/large spark guard	Nylon	n/a	●	85 g	ANSI Z87.1+, EN 166
HG7-H	2002200	High Temp Ratchet Headgear w/extra large spark guard	Nylon	n/a	●	113 g	ANSI Z87.1+, EN 166
HG5-C	2001810	High Temp Ratchet Headgear w/large spark guard and chin protector	Polycarbonate	n/a	○	113 g	ANSI Z87.1+, EN 166
HG5-H	2001800	High Temp Ratchet Headgear w/large spark guard and chin protector	Nylon	n/a	●	113 g	ANSI Z87.1+, EN 166

ACCESSORIES

Product Code	Part No.	Description	Material	Size	Color	Weight	Standard
A-CP/B	1602000	Black chin protector	Nylon	n/a	●	28 g	ANSI Z87.1+, EN 166
A-CP/C	1602100	Clear chin protector	Polycarbonate	n/a	○	28 g	ANSI Z87.1+, EN 166
A-TPH	1603900	Replacement kit of screws, washers and knobs	Nylon	n/a	●	10 g	ANSI Z87.1+, EN 166
CBA-CT	9004869	EURO clips*2	Nylon	n/a	●	15 g	ANSI Z87.1+, EN 166

* designed to meet EN 166

*2 custom clips on special request







SHADED FACE SHIELDS

The Shaded Face Shields are injection molded Nanoparticle Face Shields with various shade values for gas welding and cutting operations, and for molten metal applications. Cobalt Blue Face Shields cut the glare of the slag in molten metals and are available in Shade 3 and Shade 5. All of these products are rated for severe industrial service where high temperature and high impact may occur.







FACE SHIELDS

Product Code	Part No.	Description	Material	Size	Color	Shade	Weight	Standard	
IM9-L6F3	2108120	Shade 3 injection molded Polycarbonate Face shield	Polycarbonate	20,3 × 39,4 × 0,15 cm		3	227 g	ANSI Z87.1+	
IM9-L6F5	2108080	Shade 5 injection molded Polycarbonate Face shield	Polycarbonate	20,3 × 39,4 × 0,15 cm		5	227 g	ANSI Z87.1+	
IM12-P6F5	2110550	Shade 5 injection molded Face Shield w/hole pattern for chin protector	Tritan™	15,2 × 39,4 × 0,15 cm		5	227 g	ANSI Z87.1+, EN 166*	
IM20-L6F3	2120205	Large Shade 3 injection molded Polycarbonate Face shield, Headgear compatibility	Polycarbonate	25,4 × 50,8 × 0,15 cm		3	255 g	ANSI Z87.1+	
IM20-L6F5	2119551	Large Shade 5 injection molded Polycarbonate Face shield, Headgear compatibility	Polycarbonate	25,4 × 50,8 × 0,15 cm		5	255 g	ANSI Z87.1+	
IM22-L6F3	2119560	Large Shade 3 injection molded Polycarbonate Face shield, Bracket compatibility	Polycarbonate	25,4 × 50,8 × 0,15 cm		3	255 g	ANSI Z87.1+	
IM22-L6F5	2119550	Large Shade 5 injection molded Polycarbonate Face shield, Bracket compatibility	Polycarbonate	25,4 × 50,8 × 0,15 cm		5	255 g	ANSI Z87.1+	
IM21-L6F3	2119910	Large Shade 3 injection molded Polycarbonate Face Shield, Fibre-Metal® Bracket compatibility	Polycarbonate	25,4 × 50,8 × 0,15 cm		3	255 g	ANSI Z87.1+	
IM21-L6F5	2119920	Large Shade 5 injection molded Polycarbonate Face Shield, Fibre-Metal® Bracket compatibility	Polycarbonate	25,4 × 50,8 × 0,15 cm		5	255 g	ANSI Z87.1+	
IM20-L6FC3	2120211	Large Shade 3 Cobalt Blue injection molded Polycarbonate Face Shield, Headgear compatibility	Polycarbonate	25,4 × 50,8 × 0,15 cm		3	255 g	ANSI Z87.1+	NEW
IM20-L6FC5	2120213	Large Shade 5 Cobalt Blue injection molded Polycarbonate Face Shield, Headgear compatibility	Polycarbonate	25,4 × 50,8 × 0,15 cm		5	255 g	ANSI Z87.1+	NEW
IM22-L6FC3	2119620	Large Shade 3 Cobalt Blue injection molded Polycarbonate Face Shield, Bracket compatibility	Polycarbonate	25,4 × 50,8 × 0,15 cm		3	255 g	ANSI Z87.1+	NEW
IM22-L6FC5	2119630	Large Shade 5 Cobalt Blue injection molded Polycarbonate Face Shield, Bracket compatibility	Polycarbonate	25,4 × 50,8 × 0,15 cm		5	255 g	ANSI Z87.1+	NEW







BRACKETS

Product Code	Part No.	Description	Material	Size	Color	Shade	Weight	Standard
CB2-HD	9004860	High Temp Bracket for slotted caps w/NEW Press-to-Release US clips	Nylon	n/a		n/a	85 g	ANSI Z87.1+, EN 166
CB2-HD-CT	9004870	High Temp Bracket for slotted caps w/EURO clips	Nylon	n/a		n/a	85 g	ANSI Z87.1+, EN 166
CB6-HD	9005212	High Temp Bracket for slotted / un-slotted caps w/elastomeric band	Nylon	n/a		n/a	99 g	ANSI Z87.1+, EN 166
CB5-HD	9005050	Large High Temp Bracket for slotted caps w/NEW Press-to-Release US clips	Nylon	n/a		n/a	100 g	ANSI Z87.1+, EN 166*
HB2-HD	9102401	High Temp Bracket for slotted / un-slotted hats w/elastomeric band	Nylon	n/a		n/a	99 g	ANSI Z87.1+, EN 166*



WEIGHT COMPENSATING BRACKETS

Product Code	Part No.	Description	Material	Size	Color	Weight	Standard	
WCB-CS	9042022	Slotted Cap Bracket, Weight-compensating	Nylon	n/a		82g	ANSI Z87.1+, EN 166*	NEW
WCB-CSP	9042030	Slotted Bracket, Weight-Compensating, Petzl® Safty Helmet Compatible	Nylon	n/a		82g	ANSI Z87.1+, EN 166*	NEW
WCB-CSK	9042040	Slotted Bracket, Weight-Compensating, KASK® Safty Helmet Compatible	Nylon	n/a		82g	ANSI Z87.1+, EN 166*	NEW
WCB-CSB	9042050	Slotted Bracket, Weight-Compensating, Bullard® Safty Helmet Compatible	Nylon	n/a		82g	ANSI Z87.1+, EN 166*	NEW
WCB-CS3M	9042070	Slotted Bracket, Weight-Compensating, 3M® Safty Helmet Compatible	Nylon	n/a		82g	ANSI Z87.1+, EN 166*	NEW
WCB-CSM	9042080	Slotted Bracket, Weight-Compensating, MSA® Safty Helmet Compatible	Nylon	n/a		82g	ANSI Z87.1+, EN 166*	NEW

HEADGEAR

Product Code	Part No.	Description	Material	Size	Color	Shade	Weight	Standard
HG1-S	2000100	Pinlock headgear w/small spark guard	HDPE	n/a		n/a	86 g	ANSI Z87.1+, EN 166*
HG4-S	2001200	Ratchet headgear w/large spark guard	HDPE	n/a		n/a	86 g	ANSI Z87.1+, EN 166*
HG4-H	2001600	High Temp Ratchet Headgear w/large spark guard	Nylon	n/a		n/a	85 g	ANSI Z87.1+, EN 166
HG7-H	2002200	High Temp Ratchet Headgear w/extra large spark guard	Nylon	n/a		n/a	113 g	ANSI Z87.1+, EN 166
HG5-C	2001810	High Temp Ratchet Headgear w/large spark guard and chin protector	Polycarbonate	n/a		n/a	113 g	ANSI Z87.1+, EN 166
HG5-H	2001800	High Temp Ratchet Headgear w/large spark guard and chin protector	Nylon	n/a		n/a	113 g	ANSI Z87.1+, EN 166

ACCESSORIES

Product Code	Part No.	Description	Material	Size	Color	Shade	Weight	Standard
A-CP/B	1602000	Black chin protector	Nylon	n/a		n/a	28 g	ANSI Z87.1+, EN 166
A-CP/C	1602100	Clear chin protector	Polycarbonate	n/a		n/a	28 g	ANSI Z87.1+, EN 166
A-TPH	1603900	Replacement kit of screws, washers and knobs	Nylon	n/a		n/a	10 g	ANSI Z87.1+, EN 166
CBA-CT	9004869	EURO clips*2	Nylon	n/a		n/a	15 g	ANSI Z87.1+, EN 166

* designed to meet EN 166

*2 custom clips on special request

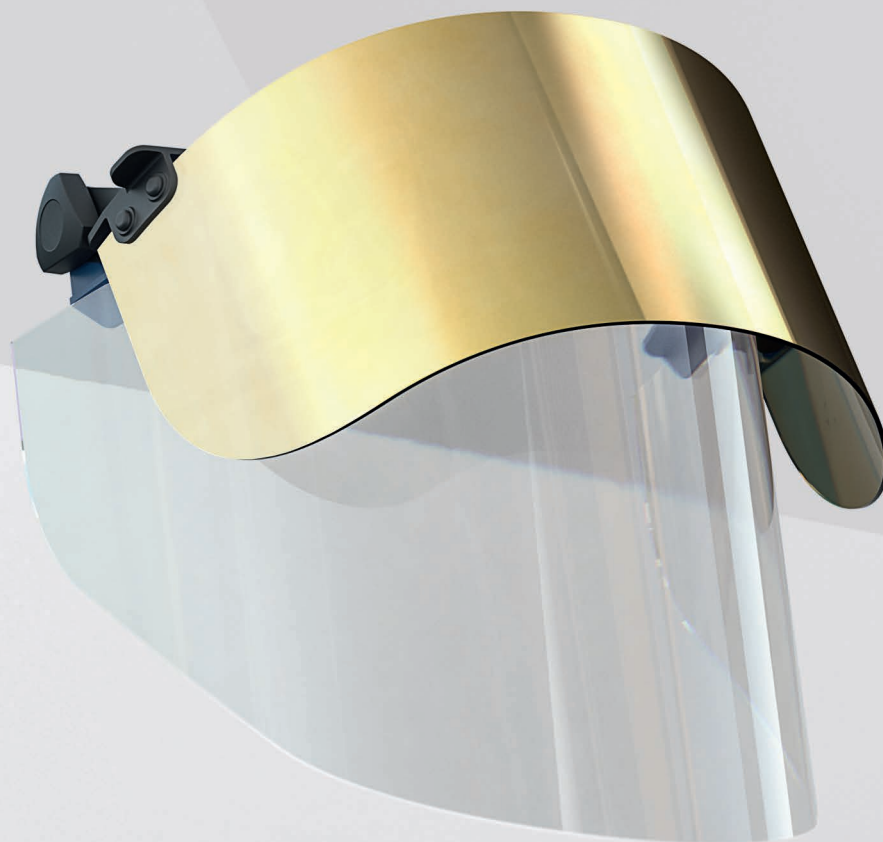



QUICKVIEW™

The Nanoparticle QuickView™ Face Shields are designed to quickly adapt to dynamic work situations. A QuickView™ flip up Face Shield, shaded or Gold coated, combined with a clear Face Shield, can make work easier and more comfortable, because the user does not need to change or lift the entire Face Shield while working or moving. Therefore, the worker remains protected.

QUICKVIEW™ FACE SHIELDS

Product Code	Part No.	Description	Material	Size	Color	Weight	Standard
QVGS3-4	2030010	Green Shade 3 QuickView™ face shield	Polycarbonate	10,16 cm		89g	ANSI Z87.1+, EN 166*
QVGS5-4	2030020	Green Shade 5 QuickView™ face shield	Polycarbonate	10,16 cm		89g	ANSI Z87.1+, EN 166*
QVCS5-4	2030080	Cobalt Blue Shade 5 QuickView™ face shield	Polycarbonate	10,16 cm		89g	ANSI Z87.1+, EN 166*
QVGHC-4	2030090	Gold on Clear QuickView™ face shield	Polycarbonate	10,16 cm		89g	ANSI Z87.1+, EN 166
QVGHCFM-4	2030100	Gold on Medium Green QuickView™ face shield	Polycarbonate	10,16 cm		89g	ANSI.Z87.1+, EN 166
QVGS3-6	2040115	Long Green Shade 3 QuickView™ face shield	Polycarbonate	15,24 cm		95g	ANSI Z87.1+, EN 166*
QVGS5-6	2040117	Long Green Shade 5 QuickView™ face shield	Polycarbonate	15,24 cm		95g	ANSI Z87.1+, EN 166*
QVCS5-6	2040123	Long Cobalt Blue Shade 5 QuickView™ face shield	Polycarbonate	15,24 cm		95g	ANSI Z87.1+, EN 166*
QVGHC-6	2040124	Long Gold on Clear QuickView™ face shield	Polycarbonate	15,24 cm		95g	ANSI.Z87.1+, EN 166
QVGHCFM-6	2040125	Long Gold on Medium Green QuickView™ face shield	Polycarbonate	15,24 cm		95g	ANSI.Z87.1+, EN 166

BASIC FACE SHIELDS

Product Code	Part No.	Description	Material	Size	Color	Weight	Standard
IM9-L6F	2107600	Clear face shield for high temp applications	Polycarbonate	20,3 × 39,4 × 0,15 cm		227g	ANSI.Z87.1+, EN 166
IM22-L6F	2119840	Large clear face shield for high temp applications	Polycarbonate	25,4 × 50,8 × 0,15 cm		255g	ANSI.Z87.1+, EN 166*

BRACKETS

Product Code	Part No.	Description	Material	Size	Color	Weight	Standard
CB2-HD	9004860	High Temp Bracket for slotted caps w/NEW Press-to-Release US clips	Nylon	n/a	●	85 g	ANSI.Z87.1+, EN 166
CB2-HD-CT	9004870	High Temp Bracket for slotted caps w/EURO clips	Nylon	n/a	●	85 g	ANSI.Z87.1+ EN 166
CB6-HD	9005212	High Temp Bracket for slotted / un-slotted caps w/elastomeric band	Nylon	n/a	●	99 g	ANSI.Z87.1+ EN 166

ACCESSORIES

Product Code	Part No.	Description	Material	Size	Color	Weight	Standard
A-TPH	1603900	Replacement kit of screws, washers and knobs	Nylon	n/a	●	10 g	ANSI.Z87.1+, EN 166
CBA-CT	9004869	EURO clips* ²	Nylon	n/a	●	15 g	ANSI.Z87.1+, EN 166

* designed to meet EN 166

*² custom clips on special request





SPECIALTY FACE SHIELDS

The Specialty Face Shields are designed for applications that require unique characteristics in form and size to provide the best possible protection and comfort to the user.

FACE SHIELDS

Product Code	Part No.	Description	Material	Size	Color	Weight	Standard
A-WS	2107900	Steel wire mesh face shield	Steel Wire	20,3 × 39,4 cm	●	142 g	ANSI Z87.1
IM11-L6F	9001200	Bubble face shield	Polycarbonate	22 × 38 cm	○	397 g	ANSI Z87.1+, EN 166*
IM11-AF6F	9001400	Premium* coated Bubble face shield	Polycarbonate	22 × 38 cm	○	397 g	ANSI Z87.1+, EN 166
S20-A4F	2209600	Mechanically formed/riveted face shield	Acetate	22,9 × 50,8 × 0,1 cm	○	227 g	ANSI Z87.1, EN 166*
S20-AF4F	2209607	Premium* coated mechanically formed/riveted face shield	Acetate	22,9 × 50,8 × 0,1 cm	○	227 g	ANSI Z87.1, EN 166*





FACE SHIELDS FOR HOODS

Product Code	Part No.	Description	Material	Size	Color	Weight	Standard
IM22-T6F-V2	2119530	Chemical splash face shield w/Velcro® for hoods	Tritan™	25,4 × 61 × 0,15 cm	○	335 g	ANSI Z87.1+

HEADGEAR

Product Code	Part No.	Description	Material	Size	Color	Weight	Standard
HG1-S	2000100	Pinlock headgear w/small spark guard	HDPE	n/a	●	86 g	ANSI Z87.1+, EN 166*
HG4-S	2001200	Ratchet headgear w/large spark guard	HDPE	n/a	●	86 g	ANSI Z87.1+, EN 166*
HG4-H	2001600	High Temp Ratchet Headgear w/large spark guard	Nylon	n/a	●	85 g	ANSI Z87.1+, EN 166
HG7-H	2002200	High Temp Ratchet Headgear w/extra large spark guard	Nylon	n/a	●	113 g	ANSI Z87.1+, EN 166

BRACKETS

Product Code	Part No.	Description	Material	Size	Color	Weight	Standard
CB2-HD	9004860	High Temp Bracket for slotted caps w/NEW Press-to-Release US clips	Nylon	n/a		85 g	ANSI Z87.1+, EN 166
CB2-HD-CT	9004870	High Temp Bracket for slotted caps w/EURO clips	Nylon	n/a		85 g	ANSI Z87.1+, EN 166
CB6-HD	9005212	High Temp Bracket for slotted / un-slotted caps w/elastomeric band	Nylon	n/a		99 g	ANSI Z87.1+, EN 166
CB5-HD	9005050	Large High Temp Bracket for slotted caps w/NEW Press-to-Release US clips	Nylon	n/a		100 g	ANSI Z87.1+, EN 166*
HB2-HD	9102401	High Temp Bracket for slotted / un-slotted hats w/elastomeric band	Nylon	n/a		99 g	ANSI Z87.1+, EN 166*

ACCESSORIES

Product Code	Part No.	Description	Material	Size	Color	Weight	Standard
A-TPH	1603900	Replacement kit of screws, washers and knobs	Nylon	n/a		10 g	ANSI Z87.1+, EN 166
CBA-CT	9004869	EURO clips* ²	Nylon	n/a		15 g	ANSI Z87.1+, EN 166

* designed to meet EN 166

*² custom clips on special request



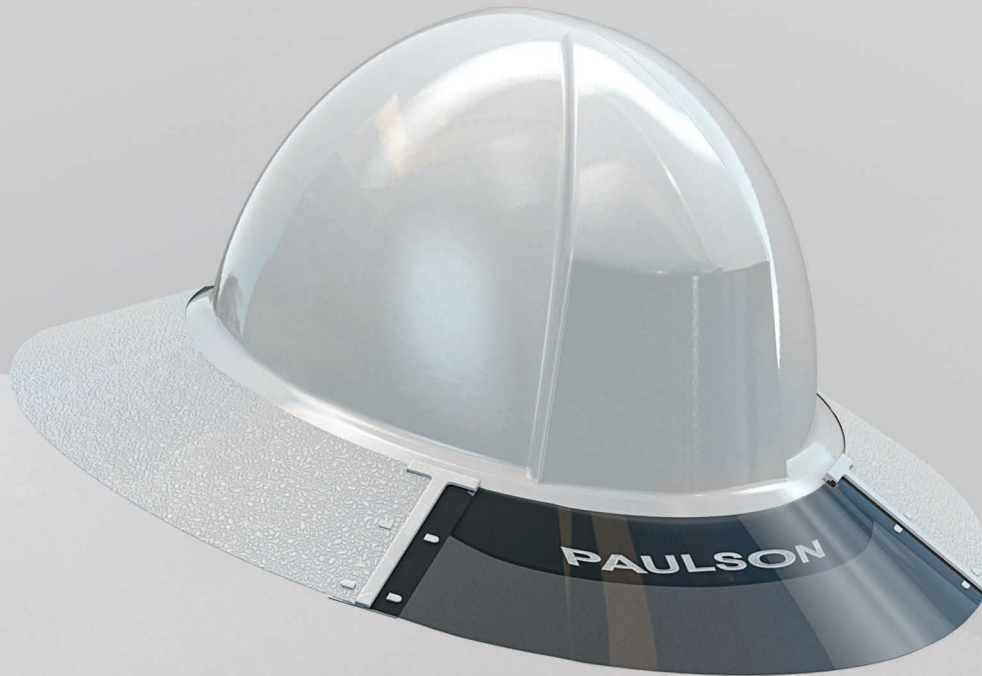











SUN SHIELDS

The Sun Shields are designed to provide additional protection from the sun, when attached to a helmet. Sun Shield models are specific to the helmet and are not interchangeable. The grey or green transparent front section allows for upward vision, and the white sections provide shade for the user. Customized Sun Shields are available on special request.

SUN SHIELDS FOR CAP STYLE HARDHATS

Product Code	Part No.	Description	Material	Color	Weight
A-S5-B	1615620	Sun Shield for Bullard® 3000 Front-Brim Cap	ABS, Polycarbonate		86 g
A-S5-F	1615660	Sun Shield for Fibre-Metal®/ North® Front-Brim Cap	ABS, Polycarbonate		86 g
A-S5-M	1615640	Sun Shield for MSA V-GARD® Front-Brim Cap	ABS, Polycarbonate		86 g
A-S5-MT	1615735	Sun Shield for MSA TOP-GARD® Front-Brim Cap	ABS, Polycarbonate		86 g
A-S3	1616000	Universal Sun Shield for Front-Brim Caps	Acetate		59 g

SUN SHIELDS FOR FULL-BRIM HARDHATS

Product Code	Part No.	Description	Material	Color	Weight
A-S4-B2	1615614	Sun Shield for Bullard® 303 Full-Brim Hat*	ABS, Polycarbonate		86 g
A-S4-F	1615650	Sun Shield for Fibre-Metal®/ North® Full-Brim Hat	ABS, Polycarbonate		86 g
A-S4-M	1615630	Sun Shield for MSA V-GARD® Full-Brim Hat	ABS, Polycarbonate		86 g
A-S4-MT	1615740	Sun Shield for MSA TOP-GARD® Full-Brim Hat	ABS, Polycarbonate		86 g
A-S4-3M	1615807	Sun Shield for 3M® H800 Full-Brim Hat	ABS, Polycarbonate		86 g
A-S1	1615600	Universal Sun Shield for Full-Brim Hats	Acetate		200 g



* newer than 2004





SPECIALTY GOGGLES

The Specialty Goggles consist of Nanoparticle Welding and Gas Cutting Goggles and Chemical Goggles. Both series have unique performance characteristics, designed for demanding applications.



GAS WELDING AND CUTTING GOGGLES

Product Code	Part No.	Description	Material	Color	Weight	Standard
510-ES3	9800035	Premium* coated Shade 3 Gas Welding and Cutting Goggle	Polycarbonate, Silicone, Plastic Alloy		227 g	ANSI Z87.1+
510-ES5	9800034	Premium* coated Shade 5 Gas Welding and Cutting Goggle	Polycarbonate, Silicone, Plastic Alloy		227 g	ANSI Z87.1+

GAS WELDING AND CUTTING GOGGLES REPLACEMENT LENSES

Product Code	Part No.	Description	Material	Color	Weight	Standard
510-LENS-PC3	9803000	Premium* coated Shade 3 Gas Welding and Cutting Goggle Replacement Lens	Polycarbonate		57 g	ANSI Z87.1+
510-LENS-PC5	9805000	Premium* coated Shade 5 Gas Welding and Cutting Goggle Replacement Lens	Polycarbonate		57 g	ANSI Z87.1+

CHEMICAL GOGGLES

Product Code	Part No.	Description	Material	Color	Weight	Standard
510-CD	9520000	Premium* coated Chemical Goggle	Polycarbonate, Silicone, Plastic Alloy		163 g	ANSI Z87.1+, EN 166* ²
510-CDN	9520001	Premium* coated Chemical Goggle w/nose shield	Polycarbonate, Silicone, Plastic Alloy		170 g	ANSI Z87.1+, EN 166* ²

* Anti-abrasion Hard Coating (outside) plus permanent Anti-fog Coating (inside)

*² designed to meet EN 166



KNEE SHIELDS

The Industrial Knee Shields provide protection above and below the knee. As the hinge joint articulates the shield, increased mobility and a large protection area is guaranteed. Different strap designs are available for specific applications.

KNEE SHIELDS

Product Code	Part No.	Description	Material	Color	Weight
1010	6258320	Knee Shield w/rubber straps and friction pad	HDPE, Plastic Alloy	●	454 g
1010-W	6258330	Knee Shield w/wide rubber straps and friction pad	HDPE, Plastic Alloy	●	454 g
1010-E	6258340	Knee Shield w/elastic straps and friction pad	HDPE, Plastic Alloy	●	454 g



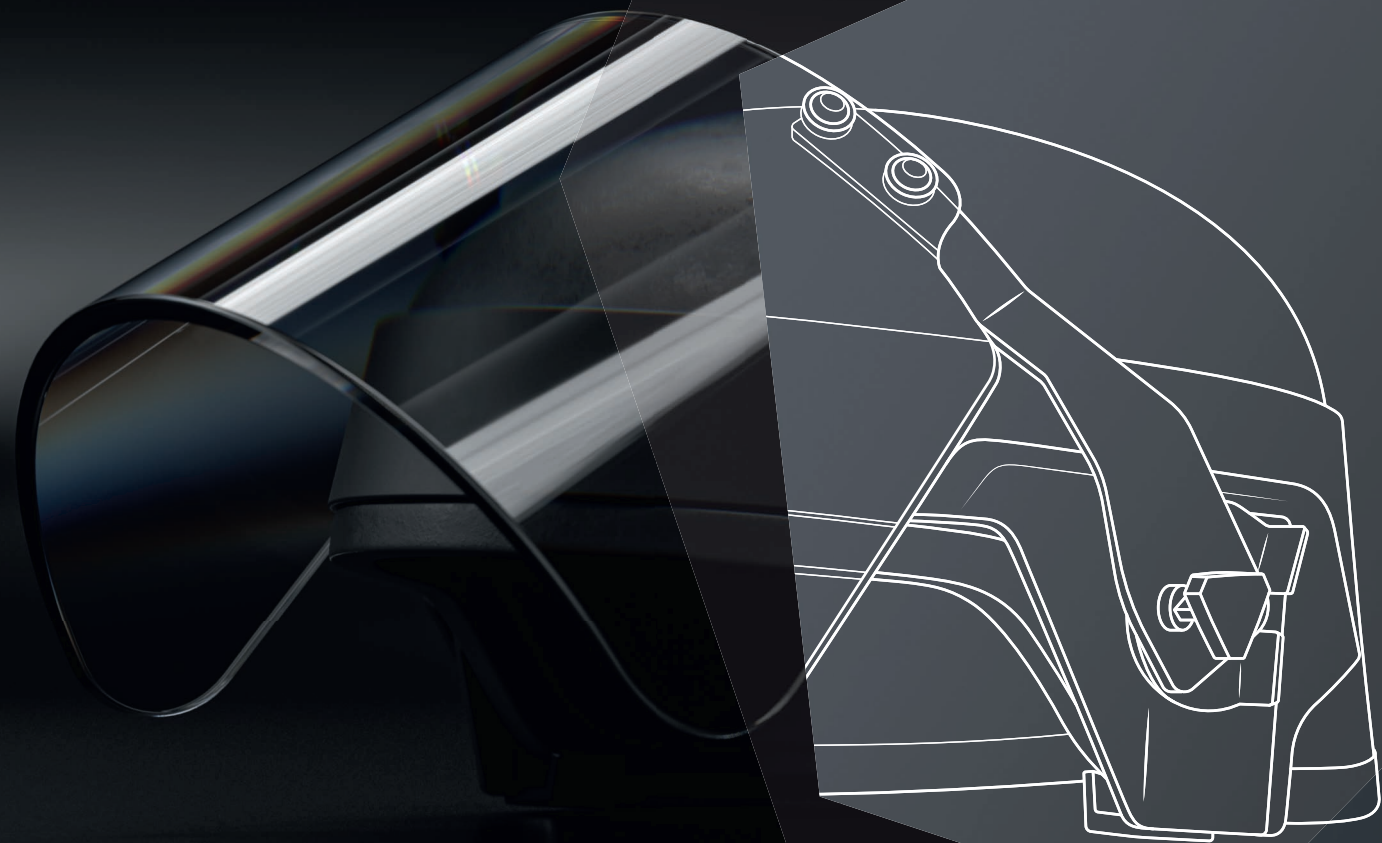

TACTICAL PPE

The PAULSON Tactical PPE is designed to support and protect professionals in forced entry situations and riot control operations. The focus is on eye, face and body protective system solutions to enable users and teams to act quickly and with flexibility.

Our Tactical Goggles, Face Shields, Body and Capture Shields, and Knee Shields are protection at the lowest weight and with superior characteristics.

The latest product development are Laser and High Intensity Light Protection Shields designed to attach to our Body Shields and Face Shields. They are designed to defend against laser attacks during protests, riots and other civil disturbances.



BODY AND CAPTURE SHIELDS

The Body and Capture Shields are manufactured from high quality Polycarbonate sheet material. A highly sophisticated manufacturing process brings the flat computer machined sheets into final shape. They are free of mechanical stress and provide high impact protection. Available with different decals, and custom decals on special request.

BODY SHIELDS

Product Code	Part No.	Description	Material	Size	Color	Weight	Standard*2
BS-2	1900014	Rectangular Body Shield w/4mm thickness	Polycarbonate, Plastic Alloy	90 × 50 × 0,4 cm	○	2722 g	EN 166*3
BS-3	1900015	Large Rectangular Body Shield w/4mm thickness	Polycarbonate, Plastic Alloy	122 × 61 × 0,4 cm	○	3860 g	Ø
BS-7	1900016	Round Body Shield w/4mm thickness	Polycarbonate, Plastic Alloy	61 × 0,4 cm	○	2155 g	Ø
BS-9	1900019	Large Rectangular Body Shield w/6mm thickness	Polycarbonate, Plastic Alloy	122 × 61 × 0,6 cm	○	6360 g	EN 166*3, STANAG 2920, MIL-STD-662F
BS-14	5200750	Rectangular Body Shield w/5mm thickness, 45 degree handle and baton holder	Polycarbonate, Plastic Alloy	120 × 56 × 0,5 cm	○	5450 g	MIL-STD-662F

CAPTURE SHIELDS

Product Code	Part No.	Description	Material	Size	Color	Weight	Standard*2
CS-8	1900018	Capture Shield w/4mm thickness	Polycarbonate, Plastic Alloy	90 × 50 × 0,4 cm	○	2722 g	Ø
CS-4	1900017	Large Capture Shield w/4mm thickness	Polycarbonate, Plastic Alloy	122 × 61 × 0,4 cm	○	3180 g	Ø
CS-5	5200400	Capture Shield w/6mm thickness	Polycarbonate, Plastic Alloy	90 × 50 × 0,6 cm	○	4550 g	Ø

ACCESSORIES

Product Code	Part No.	Description	Material	Size	Color	Weight	Standard* ²
BS-HK	5200707	Handle kit for Body Shields	Plastic Alloy	n/a	●	397 g	n/a
CS-HK	5200708	Handle kit for Capture Shields	Plastic Alloy	n/a	●	771 g	n/a
BS-24R-COV	5004034	61 cm Carry Bag for round Body Shields	Nylon Fabric	61 cm	●	148 g	n/a
BS-2036-COV	5004032	50 × 90 cm Carry Bag for rectangular Body Shields	Nylon Fabric	90 × 50 cm	●	165 g	n/a
BS-2448-COV	5004033	61 × 122 cm Carry Bag for rectangular Body Shields	Nylon Fabric	122 × 61 cm	●	490 g	n/a
BS-LAB-P	5200710	Decal POLICE*	Mylar	15,2 cm	◐	113 g	n/a
BS-LAB-S	5200711	Decal SHERIFF*	Mylar	15,2 cm	◐	113 g	n/a
BS-LAB-C	5200712	Decal CORRECTIONS*	Mylar	15,2 cm	◐	113 g	n/a

* custom decals on special request

*² specific testings on special request

*³ designed to meet EN 166





BALLISTIC BODY SHIELD

The Transparent Level IIIA Ballistic Handheld Shield is designed to be operated with one arm to allow the use of a firearm with the other hand. The transparent Polycarbonate material maximizes visibility. For right or left hand use. The Nylon fabric breakaway strap allows the user to free the supporting arm if necessary.

BALLISTIC BODY SHIELD

Product Code	Part No.	Description	Material	Size	Color	Weight	Standard*2
TA-1224	5610000	Transparent Level IIIA ballistic handheld Body Shield	Polycarbonate, Plastic Alloy	31 × 61 × 3,2 cm	○	7257 g	NU 0108.01

NEW



FACE SHIELDS

Delivering fragment protection without compromise, our Tactical Face Shields provide unique optical and mechanical properties. All Tactical Face Shields are injection molded from high grade Polycarbonate and provide UV protection. Various attachment options are available for different helmet types and applications.

DK5 SERIES

Product Code	Part No.	Description	Material	Size	Color	Weight	Standard
DK5-H.150	1900008	Standard* coated field-mount Tactical Face Shield w/PASGT compatibility and 4 mm shield thickness	Polycarbonate, Plastic Alloy	20,3 × 41,9 × 0,4 cm	○	480 g	MIL-V-43511C, NIJ 0104.02, EN 166*2
DK5-H.150S	5004005	Standard* coated short field-mount Tactical Face Shield w/PASGT compatibility and 4 mm shield thickness	Polycarbonate, Plastic Alloy	15,2 × 41,9 × 0,4 cm	○	500 g	MIL-V-43511C, NIJ 0104.02, EN 166*2
DK5-H.150SHM	5004016	Standard* coated short hard-mount Tactical Face Shield w/PASGT compatibility and 4 mm shield thickness	Polycarbonate, Plastic Alloy	15,2 × 41,9 × 0,4 cm	○	500 g	MIL-V-43511C, NIJ 0104.02, EN 166*2
DK5-X.250AF	1900011	Premium*3 coated field-mount Tactical Face Shield w/PASGT compatibility and 6 mm shield thickness	Polycarbonate, Plastic Alloy	20,3 × 41,9 × 0,64 cm	○	709 g	MIL-V-43511C, MIL-STD-662F, NIJ 0104.02, EN 166*2
DK5-X.250AFS	5006052	Premium*3 coated short field-mount Tactical Face Shield w/PASGT compatibility and 6 mm shield thickness	Polycarbonate, Plastic Alloy	15,2 × 41,9 × 0,64 cm	○	553 g	NIJ 0104.02
DK5-X.250AFHM	5006011	Premium*3 coated short hard-mount Tactical Face Shield w/PASGT compatibility and 6 mm shield thickness	Polycarbonate, Plastic Alloy	20,3 × 41,9 × 0,64 cm	○	553 g	NIJ 0104.02
DK5/6-COV	5004029	Fabric cover for DK5 and DK6 Tactical Face Shields	Nylon Fabric	n/a	●	43 g	n/a

DK6 SERIES

Product Code	Part No.	Description	Material	Size	Color	Weight	Standard
DK6-H.150	5800000	Standard* coated universal field-mount Tactical Face Shield w/4 mm thickness	Polycarbonate, Plastic Alloy	20,3 × 41,9 × 0,4 cm	○	680 g	MIL-V-43511C, NIJ 0104.02, EN 166*2
DK6-H.150S	5800004	Standard* coated short universal field-mount Tactical Face Shield w/4 mm thickness	Polycarbonate, Plastic Alloy	15,2 × 41,9 × 0,4 cm	○	680 g	MIL-V-43511C, NIJ 0104.02, EN 166*2
DK6-X.250AF	5800101	Premium*3 coated universal field-mount Tactical Face Shield w/6 mm thickness	Polycarbonate, Plastic Alloy	20,3 × 41,9 × 0,64 cm	○	860 g	MIL-V-43511C, NIJ 0104.02, EN 166*2
DK6-X.250AFS	5800105	Premium*3 coated short universal field-mount Tactical Face Shield w/6 mm thickness	Polycarbonate, Plastic Alloy	15,2 × 41,9 × 0,64 cm	○	590 g	MIL-V-43511C, NIJ 0104.02, EN 166*2
DK6-X.250AF-N	5800131	Premium*3 coated universal field-mount Nylon Tactical Face Shield w/6 mm thickness	Nylon, Plastic Alloy	20,3 × 41,9 × 0,64 cm	○	700 g	MIL-STD-662F, EN 166*2
DK5/6-COV	5004029	Fabric cover for DK5 and DK6 Tactical Face Shields	Nylon Fabric	n/a	●	43 g	n/a

DK7 SERIES

Product Code	Part No.	Description	Material	Size	Color	Weight	Standard	
DK7-X.250AF	5900101	Premium* ³ coated universal field-mount Tactical Face Shield w/6 mm thickness	Polycarbonate, Plastic Alloy	15,2 × 39,4 × 0,64 cm	○	860 g	MIL-V-43511C, NIJ 0104.02, EN 166* ²	
DK7-X.250AF-RU	5900200	Premium* ³ coated rail-mount Tactical Face Shield w/6 mm thickness, United Shield® compatible	Polycarbonate, Plastic Alloy	15,2 × 39,4 × 0,64 cm	○	626 g	NIJ 0104.02, EN 166* ²	NEW
DK7-H.150-RC	5900500	Standard* coated rail-mount Tactical Face Shield w/4 mm thickness, Ops-Core® compatible	Polycarbonate, Plastic Alloy	15,2 × 39,4 × 0,38 cm	○	476 g	NIJ 0104.02	NEW
DK7-H.150-RU	5900300	Standard* coated rail-mount Tactical Face Shield w/4 mm thickness, United Shield® compatible	Polycarbonate, Plastic Alloy	15,2 × 39,4 × 0,38 cm	○	476 g	NIJ 0104.02	NEW
DK7-X.250AF-RC	5900400	Premium* ³ coated rail-mount Tactical Face Shield w/6 mm thickness, Ops-Core® compatible	Polycarbonate, Plastic Alloy	15,2 × 39,4 × 0,64 cm	○	626 g	NIJ 0104.02	NEW
DK7-X.250AF-RCL	5900450	Premium* ³ coated rail-mount Tactical Face Shield w/6 mm thickness and liquid seal, Ops-Core® compatible	Polycarbonate, Plastic Alloy	15,2 × 39,4 × 0,64 cm	○	635 g	NIJ 0104.02	NEW
DK7-X.250AF-RUL	5900350	Premium* ³ coated rail-mount Tactical Face Shield w/6 mm thickness and liquid seal, United Shield® compatible	Polycarbonate, Plastic Alloy	15,2 × 39,4 × 0,64 cm	○	635 g	NIJ 0104.02	NEW
DK7-X.250AF-RC-S5	5900600	Premium* ³ coated rail-mount Tactical Breaching Face Shield w/6 mm thickness, Ops-Core® compatible	Polycarbonate, Plastic Alloy	20 × 39,4 × 0,64 cm	○	626 g	NIJ 0104.02	NEW
DK7 COV	5900111	Fabric cover for DK7 Tactical Face Shields w/Velcro® closure	Nylon Fabric	n/a	●	43 g	n/a	

* Non-permanent Anti-fog Coating

*² designed to meet EN 166

*³ Anti-abrasion Hard Coating (outside) plus permanent Anti-fog Coating (inside)



LASER PROTECTION

Our Tactical Laser Protection consists of Laser and High Intensity Light Protection Shields to be field mounted without tools to the front of our Tactical Face Shields and Body Shields. They are designed to block high intensity light beams and to reduce the dazzle effect of red, green, blue, violet and other colors of laser pointers.

LASER AND HIGH INTENSITY LIGHT PROTECTION FOR FACE SHIELDS

Product Code	Part No.	Description	Material	Size	Color	Weight	Standard	
TLS-F56	5901003	Laser and high intensity light protection shield for DK5 and DK6 Tactical Face Shields	Polycarbonate	7,62 × 38 cm	●	29 g	ANSI Z136, ANSI Z87.1 L4	NEW
TLS-F7	5901004	Laser and high intensity light protection shield for DK7 Tactical Face Shields	Polycarbonate	8,89 × 38 cm	●	27 g	ANSI Z136, ANSI Z87.1 L4	NEW
TLS-F7L	5901210	Laser and high intensity light protection shield for DK7 Tactical Face Shields w/liquid seal	Polycarbonate	7,62 × 38 cm	●	25 g	ANSI Z136, ANSI Z87.1 L4	NEW
TLSR-F56	5921003	Reflective laser and high intensity light protection shield for DK5 and DK6 Tactical Face Shields	Polycarbonate	7,62 × 38 cm	●	29 g	ANSI Z136, ANSI Z87.1 L4	NEW
TLSR-F7	5921004	Reflective laser and high intensity light protection shield for DK7 Tactical Face Shields	Polycarbonate	8,89 × 38 cm	●	27 g	ANSI Z136, ANSI Z87.1 L4	NEW
TLSR-F7L	5921005	Reflective laser and high intensity light protection shield for DK7 Tactical Face Shields w/liquid seal	Polycarbonate	7,62 × 38 cm	●	25 g	ANSI Z136, ANSI Z87.1 L4	NEW

LASER AND HIGH INTENSITY LIGHT PROTECTION FOR BODY SHIELDS

Product Code	Part No.	Description	Material	Size	Color	Weight	Standard	
TLS-B2	5901001	Laser and high intensity light protection shield for BS-2 Body Shield	Polycarbonate	15,2 × 50,8 cm	●	93 g	ANSI Z136, ANSI Z87.1 L4	NEW
TLS-B39	5901000	Laser and high intensity light protection shield for BS-3 and BS-9 Body Shields	Polycarbonate	15,2 × 61 cm	●	117 g	ANSI Z136, ANSI Z87.1 L4	NEW
TLS-B7	5901002	Laser and high intensity light protection shield for BS-7 Body Shield	Polycarbonate	15,2 × 50,8 cm	●	82 g	ANSI Z136, ANSI Z87.1 L4	NEW
TLSR-B2	5921001	Reflective laser and high intensity light protection shield for BS-2 Body Shield	Polycarbonate	15,2 × 50,8 cm	●	93 g	ANSI Z136, ANSI Z87.1 L4	NEW
TLSR-B39	5921000	Reflective laser and high intensity light protection shield for BS-3 and BS-9 Body Shields	Polycarbonate	15,2 × 61 cm	●	117 g	ANSI Z136, ANSI Z87.1 L4	NEW
TLSR-B7	5921002	Reflective laser and high intensity light protection shield for BS-7 Body Shield	Polycarbonate	15,2 × 50,8 cm	●	82 g	ANSI Z136, ANSI Z87.1 L4	NEW



GOGGLES

The Tactical Goggles combine the best protection at lowest weight to highest wearing comfort ratio. Highest fragment and splash protection is provided through the unique design features of the product. Available with dual lens or triple lens for maximum fragment protection. All models are Premium coated for the best performance in the field and a long service life.

GOGGLES

Product Code	Part No.	Description	Material	Color	Weight	Standard
510-T	1900002	Premium* coated Tactical Goggle w/dual lens	Polycarbonate, Silicone, Elastic	●	163 g	MIL-V-43511C, EN 166* ² , ANSI Z87.1+
510-TN	1900001	Premium* coated Tactical Goggle w/dual lens and nose shield	Polycarbonate, Silicone, Elastic	●	170 g	STANAG 2920, MIL-V-43511C, EN 166* ² , ANSI Z87.1+
510-TF	1900003	Premium* coated Tactical Goggle w/triple lens	Polycarbonate, Silicone, Elastic	●	191 g	STANAG 2920, MIL-STD-662F, EN 166* ² , ANSI Z87.1+
510-TFN	1900004	Premium* coated Tactical Goggle w/triple lens and nose shield	Polycarbonate, Silicone, Elastic	●	198 g	STANAG 2920, EN 166* ² , ANSI Z87.1+

REPLACEMENT LENSES

Product Code	Part No.	Description	Material	Color	Weight	Standard
510-DL	1900005	Premium* coated Tactical Goggle Replacement dual lens	Polycarbonate	○	51 g	EN 166* ² , ANSI Z87.1+
510-TF-RL	9201013	Premium* coated Tactical Goggle Replacement triple lens	Polycarbonate	○	57 g	EN 166* ² , ANSI Z87.1+

ACCESSORIES

Product Code	Part No.	Description	Material	Color	Weight	Standard
A-GLCC	9409900	Clear disposable self-adhesive cover lens (5 units)	Mylar	○	3 g	n/a

* Anti-abrasion Hard Coating (outside) plus permanent Anti-fog Coating (inside)

*² designed to meet EN 166



KNEE SHIELDS

The Tactical Knee Shields are designed to protect the sensitive areas of the knees and elbows against various impacts and hazards expected in operation. They are available with large Velcro® fasteners or rubber closure straps, featuring one size fits all.

KNEE SHIELDS

Product Code	Part No.	Description	Material	Color	Weight	Size
1010-EB	1900006	Knee Shield w/articulated rigid shell and foam pad plus heavy elastic adjustment feature	Plastic Alloy, Elastic	●	454 g	one size fits all
1010-ET	1900007	Knee Shield w/articulated rigid shell and foam pad plus heavy elastic and Velcro® adjustment feature	Plastic Alloy, Elastic	●	454 g	one size fits all



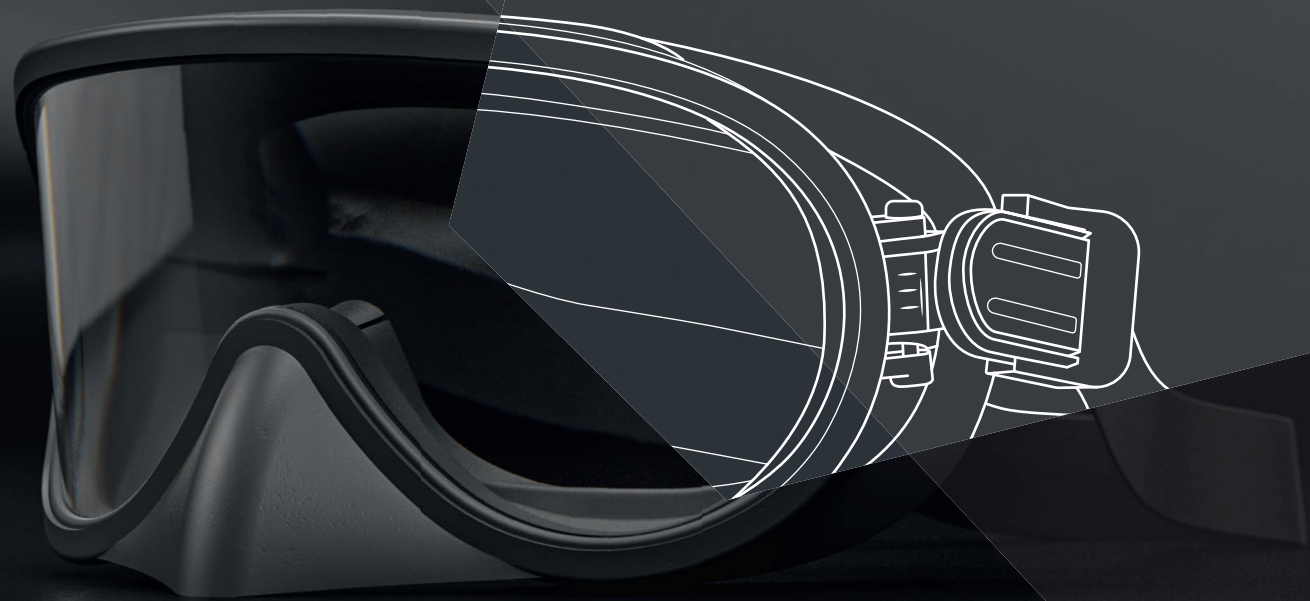

FIREFIGHTER PPE

Firefighters rely on a wide range of PPE to do their job safely and effectively, including proper eye protection. Without appropriate Safety Goggles, firefighters can suffer eye damage from debris or heat exposure.

Our Firefighter PPE consists of Structural and Wildland Goggles, which are designed for firefighting operations and other emergency operations where there is a threat of fire and severe physical hazards.



STRUCTURAL GOGGLES

The Structural Goggles are designed to specifically address the needs of firefighters battling structural fires in urban or industrial work environments. Coming with an APEC® lens module and being optically corrected, these Goggles provide extreme heat and impact resistance. Our Structural Goggles can withstand 260° Celsius for more than 5 minutes. They are available with or without nose protection, and with multiple attachment options.

GOGGLES

Product Code	Part No.	Description	Material	Color	Weight	Standard
510-E	9800001	Premium* coated Structural Fire Goggle w/elastic strap	APEC®, Silicone, Kevlar Elastic, Plastic Alloy	●○	156 g	NFPA 1971, 1977, 1951, ANSI Z87.1+, EN 166* ²
510-EN	9800002	Premium* coated Structural Fire Goggle w/elastic strap and nose shield	APEC®, Silicone, Kevlar Elastic, Plastic Alloy	●○	156 g	NFPA 1971, 1977, 1951, ANSI Z87.1+, EN 166* ²
510-EB	9800003	Premium* coated Structural Fire Goggle w/elastic strap and center buckle	APEC®, Silicone, Kevlar Elastic, Plastic Alloy	●○	156 g	NFPA 1971, 1977, 1951, ANSI Z87.1+, EN 166* ²
510-SL	9800011	Premium* coated Structural Fire Goggle w/Silicone strap	APEC®, Silicone, Kevlar Elastic, Plastic Alloy	●○	170 g	NFPA 1971, 1977, 1951, ANSI Z87.1+, EN 166* ²
510-SLN	9411100	Premium* coated Structural Fire Goggle w/Silicone strap and nose shield	APEC®, Silicone, Kevlar Elastic, Plastic Alloy	●○	170 g	NFPA 1971, 1977, 1951, ANSI Z87.1+, EN 166* ²

REPLACEMENT LENS

Product Code	Part No.	Description	Material	Color	Weight	Standard
510-AL	9201050	Premium* coated Structural Fire Goggle replacement lens	APEC®	○	14 g	NFPA 1971, 1977, 1951, ANSI Z87.1+, EN 166* ²

REPLACEMENT STRAPS

Product Code	Part No.	Description	Material	Color	Weight	Standard
510-ES	9302300	Replacement elastic strap	Kevlar Elastic	●	14 g	NFPA 1971, 1977, 1951
510-ESA	9301900	Replacement elastic strap assembly	Kevlar Elastic, Plastic Alloy	●	14 g	NFPA 1971, 1977, 1951
510-ESAB	9300000	Replacement elastic strap assembly w/center buckle	Kevlar Elastic, Plastic Alloy	●	14 g	NFPA 1971, 1977, 1951
510-SS	9200320	Replacement Silicone strap	Silicone	●	14 g	NFPA 1971, 1977, 1951
510-SSA	9301100	Replacement Silicone strap assembly	Silicone, Plastic Alloy	●	14 g	NFPA 1971, 1977, 1951

ACCESSORIES

Product Code	Part No.	Description	Material	Color	Weight	Standard
A-GC	9201700	Strap controlling clip system for Structural Helmets	Plastic Alloy	●	3 g	NFPA 1971, 1977, 1951
A-PC	9201711	Strap controlling clip system for Phenix® Helmets	Plastic Alloy	●	3 g	NFPA 1971, 1977, 1951
A-GLCC	9409900	Clear disposable self-adhesive cover lens (5 units)	Mylar/Adhesive	○	3 g	n/a

* Anti-abrasion Hard Coating (outside) plus permanent Anti-fog Coating (inside)

*² designed to meet EN 166



WILDLAND GOGGLES

The Wildland Goggles are specifically designed for the needs of firefighters battling wildland fires. These Goggles include a Polycarbonate lens system that is optically corrected. They provide superior protection from high heat and impact. Our Wildland Goggles passed heat exposure tests at 177° Celsius. They are available with or without nose protection, and with multiple attachment options.

GOGGLES

Product Code	Part No.	Description	Material	Color	Weight	Standard
510-WE	9800017	Premium* coated Wildland Fire Goggle w/elastic strap	Polycarbonate, Silicone, Kevlar Elastic, Plastic Alloy	●○	156 g	NFPA 1977, ANSI Z87.1+, EN 166* ²
510-WEN	9800018	Premium* coated Wildland Fire Goggle w/elastic strap and nose shield	Polycarbonate, Silicone, Kevlar Elastic, Plastic Alloy	●○	156 g	NFPA 1977, ANSI Z87.1+, EN 166* ²
510-WEB	9800019	Premium* coated Wildland Fire Goggle w/elastic strap and center buckle	Polycarbonate, Silicone, Kevlar Elastic, Plastic Alloy	●○	156 g	NFPA 1977, ANSI Z87.1+, EN 166* ²
510-WSL	9601500	Premium* coated Wildland Fire Goggle w/Silicone strap	Polycarbonate, Silicone, Kevlar Elastic, Plastic Alloy	●○	170 g	NFPA 1977, ANSI Z87.1+, EN 166* ²
510-WSLN	9611100	Premium* coated Wildland Fire Goggle w/Silicone strap and nose shield	Polycarbonate, Silicone, Kevlar Elastic, Plastic Alloy	●○	170 g	NFPA 1977, ANSI Z87.1+, EN 166* ²

REPLACEMENT LENS

Product Code	Part No.	Description	Material	Color	Weight	Standard
510-WL	9800029	Premium* coated Wildland Fire Goggle replacement lens	Polycarbonate	○	14 g	NFPA 1977, ANSI Z87.1+, EN 166* ²

REPLACEMENT STRAPS

Product Code	Part No.	Description	Material	Color	Weight	Standard
510-ES	9302300	Replacement elastic strap	Kevlar Elastic	●	14 g	NFPA 1971, 1977, 1951
510-ESA	9301900	Replacement elastic strap assembly	Kevlar Elastic, Plastic Alloy	●	14 g	NFPA 1971, 1977, 1951
510-ESAB	9300000	Replacement elastic strap assembly w/center buckle	Kevlar Elastic, Plastic Alloy	●	14 g	NFPA 1971, 1977, 1951
510-SS	9200320	Replacement Silicone strap	Silicone	●	14 g	NFPA 1971, 1977, 1951
510-SSA	9301100	Replacement Silicone strap assembly	Silicone, Plastic Alloy	●	14 g	NFPA 1971, 1977, 1951

ACCESSORIES

Product Code	Part No.	Description	Material	Color	Weight	Standard
A-GC	9201700	Strap controlling clip system for Structural Helmets	Plastic Alloy	●	3 g	NFPA 1971, 1977, 1951
A-PC	9201711	Strap controlling clip system for Phenix® Helmets	Plastic Alloy	●	3 g	NFPA 1971, 1977, 1951
A-GLCC	9409900	Clear disposable self-adhesive cover lens (5 units)	Mylar/Adhesive	○	3 g	n/a

* Anti-abrasion Hard Coating (outside) plus permanent Anti-fog Coating (inside)

*² designed to meet EN 166

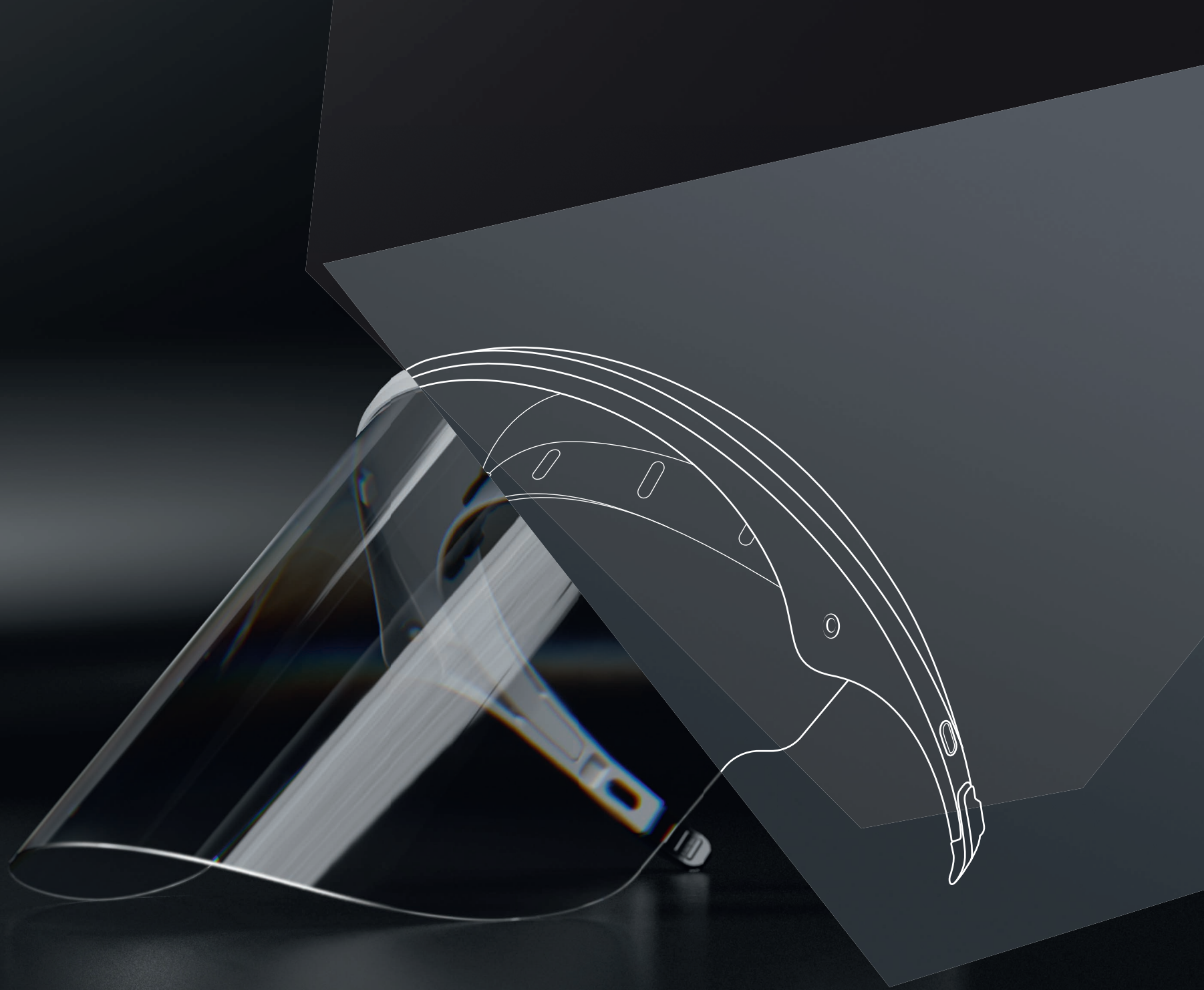

MEDICAL PPE

Infectious Disease Control (IDC) refers to the measures put into place to reduce or prevent the spread of contagious pathogens in healthcare settings and other situations where workers cannot avoid exposure. PPE is critical to any successful IDC plan, as it provides a necessary layer of protection from potentially contaminated air or surfaces. Protective gear is typically used by medical personnel but is especially important for any individual who experiences regular exposure to the public during pandemics.

The PAULSON Medical PPE consists of Reusable IDC Face Shields and Disposable IDC Face Shields and Goggles. It is designed to provide superior protection against infectious diseases like Covid 19.



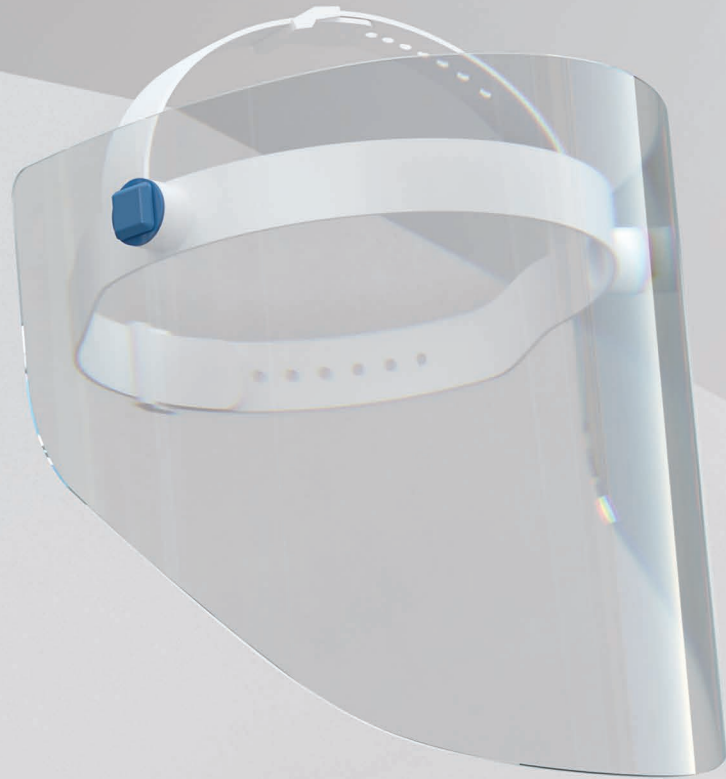







Although IDC Goggles are often overlooked in PPE contexts, they are critical to ensuring total protection for health care workers and other frontline personnel, as individuals can be exposed to infectious pathogens through the mucous membranes of the eye. IDC Face Shields offer additional protection of the entire face, further reducing potential exposure, particularly when used in conjunction with goggles and face masks.



REUSABLE IDC FACE SHIELDS

Our Reusable IDC Shields are high quality IDC Shields to help reduce the wearer's exposure to airborne particles, splashed or sprayed bodily fluids. All Reusable IDC Shields are designed and manufactured to stringent safety and quality standards, with particular attention to style, comfort and adjustability.

REUSABLE IDC FACE SHIELDS

Product Code	Part No.	Description	Material	Color	Weight	Standard	
IDC/S-1	6256101	IDC w/pin lock headband and 1 face shield	Polycarbonate, Polyethylene		87 g	OSHA 1910.1030, EN 166*, ANSI Z87.1 D3* ²	NEW
IDC/S-25	6256500	IDC w/pin lock headband and 25 face shields	Polycarbonate, Polyethylene		87 g	OSHA 1910.1030, EN 166*, ANSI Z87.1 D3* ²	NEW
IDC/SE-1	6256601	IDC w/elastic headband and 1 face shield	Polycarbonate, Elastic		87 g	OSHA 1910.1030, EN 166*, ANSI Z87.1 D3* ²	NEW
IDC/SE-25	6256600	IDC w/elastic headband and 25 face shields	Polycarbonate, Elastic		87 g	OSHA 1910.1030, EN 166*, ANSI Z87.1 D3* ²	NEW
IDC/SH-1	6256300	IDC w/universal cap bracket elastometric band and 1 face shield	Polycarbonate, Polyethylene, Elastomer		87 g	OSHA 1910.1030, EN 166*, ANSI Z87.1 D3* ²	NEW
IDC/SH-25	6253525	IDC w/universal cap bracket elastometric band and 25 face shields	Polycarbonate, Polyethylene, Elastomer		87 g	OSHA 1910.1030, EN 166*, ANSI Z87.1 D3* ²	NEW
IDC/S-RS	6256550	25 replacement IDC shields, compatible w/pin lock and elastic models	Polycarbonate		34 g	OSHA 1910.1030, EN 166*, ANSI Z87.1 D3* ²	NEW
IDC/SH-RS	6253526	25 replacement IDC shields, compatible w/hat brackets	Polycarbonate		34 g	OSHA 1910.1030, EN 166*, ANSI Z87.1 D3* ²	NEW
IDC/S-HB	6251600	Replacement pin lock headband for IDC shields	Polyethylene		53 g	OSHA 1910.1030, EN 166*, ANSI Z87.1 D3* ²	NEW
IDC/S-HBE	6256602	Replacement elastic headband for IDC shields	Elastic, Polyethylene		53 g	OSHA 1910.1030, EN 166*, ANSI Z87.1 D3* ²	NEW
IDC/SH-HA	6253550	Replacement universal cap bracket w/elastomeric band for IDC shields	Polyethylene, Elastomer		53 g	OSHA 1910.1030, EN 166*, ANSI Z87.1 D3* ²	NEW

* tested to EN 166 (except EN 166 Subclause 7.1.4.1 b)









*² not impact rated



DISPOSABLE IDC FACE SHIELDS AND GOGGLES

Our Disposable IDC Face Shields and Goggles are lightweight and easy to use. A universal fitting allows general deployment to any user. Simple is better, and ease of use is paramount for user safety.

DISPOSABLE IDC FACE SHIELDS AND GOGGLES

Product Code	Part No.	Description	Material	Color	Weight	Standard
IDC/F CE	6256411	CE labeled IDC shield w/elastic band and foam forehead cushion (5 units)	Polycarbonate, Polyester, Elastic		28 g	OSHA 1910.1030, EN 166*
IDC/F-100 CE	6256430	CE labeled IDC shield w/elastic band and foam forehead cushion (100 units)	Polycarbonate, Polyester, Elastic		28 g	OSHA 1910.1030, EN 166*
IDC/GAF CE	4630007	CE labeled IDC goggle w/elastic band and foam cushion (1 unit)	Polycarbonate, Polyester, Elastic		9 g	OSHA 1910.1030, EN 166*
IDC/GAF-100 CE	4630016	CE labeled IDC goggle w/elastic band and foam cushion (100 units)	Polycarbonate, Polyester, Elastic		9 g	OSHA 1910.1030, EN 166*
IDC/F	6256410	IDC shield w/elastic band and foam forehead cushion (5 units)	Polycarbonate, Polyester, Elastic		28 g	OSHA 1910.1030, EN 166*
IDC/F-100	6256413	IDC shield w/elastic band and foam forehead cushion (100 units)	Polycarbonate, Polyester, Elastic		28 g	OSHA 1910.1030, EN 166*
IDC/GAF	4630000	IDC goggle w/elastic band and foam cushion (1 unit)	Polycarbonate, Polyester, Elastic		9 g	OSHA 1910.1030, EN 166*
IDC/GAF-100	4630002	IDC goggle w/elastic band and foam cushion (100 units)	Polycarbonate, Polyester, Elastic		9 g	OSHA 1910.1030, EN 166*

* tested to EN 166 (except EN 166 Subclause 7.1.4.1 b)

LEGAL NOTE

© PAULSON International GmbH
Max-Holder-Str. 23
60437 Frankfurt/Main
Germany

info@paulson-international.com
www.paulson-international.com

Legal Form: GmbH
Registered Office: Max-Holder-Str. 23,
60437 Frankfurt/Main, Germany
Register Court: Frankfurt/Main / HRB 119756

Concept, Design, Pictures, Illustrations
Neil Riot, Jan-Paul Seifert
neilriot.com

Changes and errors reserved. Pictures and
illustrations similar.

Reproduction and electronic duplication only
with our written permission.

Our general terms and conditions apply which
you can request from us or read on our website:
www.paulson-international.com



Paulson International GmbH

Max-Holder-Str. 23 · 60437 Frankfurt/Main · Germany
T +49 (0)69 90 50 585-0 · F +49 (0)69 90 50 585-20

info@paulson-international.com
www.paulson-international.com